

Medallion

52oz. Popcorn Machine



Instruction Manual







GOLD MEDAL® PRODUCTS CO.



10700 Medallion Drive, Cincinnati, Ohio 45241-4807 USA



SAFETY PRECAUTIONS

	 DANGER
	<p>Machine must be properly grounded to prevent electrical shock to personnel. Failure to do so could result in serious injury, or death.</p> <p>Make sure all machine switches are in the OFF position before plugging the equipment into the receptacle. Keep cord and plug off the ground and away from moisture. Always unplug the equipment before cleaning or servicing.</p> <p>DO NOT immerse any part of this equipment in water.</p> <p>DO NOT use a water jet or excessive water when cleaning.</p> <p style="text-align: right;">008_012221</p>



	 DANGER
	<p>Improper installation, adjustment, alteration, service, or maintenance can cause property damage, injury, or death. Any alterations to this equipment will void the warranty and may cause a dangerous condition. This appliance is not intended to be operated by means of an external timer or separate remote-control system. NEVER make alterations to this equipment. Read the Installation, Operating, and Maintenance Instructions thoroughly before installing, servicing, or operating this equipment.</p> <p style="text-align: right;">014_020416</p>



	 WARNING
	<p>To avoid burns, DO NOT touch the kettle or any heated surface.</p> <p>DO NOT place or leave objects in contact with heated surfaces.</p> <p style="text-align: right;">013_092414</p>



	 WARNING
	<p>ALWAYS wear safety glasses when servicing this equipment.</p> <p style="text-align: right;">010_010914</p>

	 WARNING
	<p>No user serviceable parts inside. Refer servicing to qualified service personnel.</p> <p style="text-align: right;">011_051514</p>

	 WARNING
	<p>Read and understand operator's manual and all other safety instructions before using this equipment. To order copies of the operator's manual go to gmpopcorn.com or write to Gold Medal Products Co., 10700 Medallion Drive, Cincinnati, OH 45241 USA 1-(800)-543-0862</p> <p style="text-align: right;">022_060215</p>

	 WARNING
	<p>DO NOT allow direct contact of this equipment by the public when used in food service locations. Only personnel trained and experienced in the equipment operation may operate this equipment.</p> <p>Carefully read all instructions before operation.</p> <p style="text-align: right; font-size: small;">012_010914</p>

	 WARNING
	<p>This machine is NOT to be operated by minors.</p> <p style="text-align: right; font-size: small;">007_010914</p>

	 CAUTION
	<p>If the supply cord is damaged, it must be replaced by Gold Medal Products Co., its service agent or similarly qualified persons in order to avoid a hazard.</p> <p style="text-align: right; font-size: small;">039_080614</p>

This appliance is not intended for use by persons (including children) with reduced physical, sensory or mental capabilities, or lack of experience and knowledge, unless they have been given supervision or instruction concerning use of the appliance by a person responsible for their safety.

DO NOT install equipment in an area where a water jet is used.

Unit to be installed in locations where ambient temperatures are between a minimum of 5°C (41°F) and a maximum of 55°C (131°F).

Unit to be installed in locations where it can be overseen by trained personnel.

Install unit on a level surface.

Unit is for popcorn.

Note: Improvements are always being made to Gold Medal's equipment. This information may not be the latest available for your purposes. It is critical that you call Gold Medal's Technical Service Department at 1-800-543-0862 for any questions about your machine operations, replacement parts, or any service questions. (Gold Medal Products Co. does not assume any liability for injury due to careless handling and/or reckless operation of this equipment.) General images may be used in manual for reference only.

INSTALLATION INSTRUCTIONS

Inspection of Shipment

After unpacking, check thoroughly for any damage which may have occurred in transit. Claims should be filed immediately with the transportation company. The warranty does not cover damage that occurs in transit, or damage caused by abuse, or consequential damage due to the operation of this machine, since it is beyond our control (reference warranty in back of manual).

Manual

Read and understand the operator's manual and all other safety instructions before using this equipment. To order copies of the operator's manual go to gmpopcorn.com or write to Gold Medal Products Co., 10700 Medallion Drive, Cincinnati, OH 45241 USA 1-(800)-543-0862.

Electrical Requirements

The following power supply must be provided:

DOMESTIC UNITS: 120/208 or 120/240 V~, 60 Hz (reference unit Data Plate for Wattage requirement)



Domestic units are designed to operate on single phase, 50 AMP, 4 wire supply, 120/208 or 120/240 V~ (2 Hot, 1 Neutral, 1 Ground). All electrical components in this machine are 120 V (motors, heat elements, lights, etc.) and therefore require "Hot to Neutral" connection (NOT "Hot to Hot"). A 50 AMP wall receptacle (NEMA 14-50) is supplied with the machine. The receptacle will accept the attachment plug on the machine and must be used; reference the Receptacle Wiring Diagram for NEMA 14-50 for receptacle installation instructions.

EXPORT UNITS: 220-230 V~, 50/60 Hz (reference unit Data Plate for Wattage requirement)

Potential Electrical Variations: 220 V~, 60 Hz

Export units are designed to operate on single phase, 16 AMP, 4 wire supply, 230 V~ (2 Hot, 1 Neutral, 1 Ground). All electrical components in this machine are 230 V (motors, heat elements, lights, etc.) and therefore require "Hot to Neutral" connection (NOT "Hot to Hot"). A certified electrician must supply and install the wall receptacle for this unit; reference the Receptacle Wiring Diagram for Export Units.

Australia - 52 oz. units are designed to operate on single phase, 36 AMP, 2 wire supply, plus ground. All electrical components in machine are 230 V (motors, heat elements, lights, etc.) A certified electrician must supply and install the wall receptacle for this unit.

	 DANGER
<p>Machine must be properly grounded to prevent electrical shock to personnel. Failure to do so could result in serious injury, or death.</p> <p>Make sure all machine switches are in the OFF position before plugging the equipment into the receptacle. Keep cord and plug off the ground and away from moisture. Always unplug the equipment before cleaning or servicing.</p> <p>DO NOT immerse any part of this equipment in water.</p> <p>DO NOT use a water jet or excessive water when cleaning.</p>	
<small>008_012221</small>	

A certified electrician must furnish sufficient power for proper machine operation and install any supplied receptacle (reference unit Data Plate for model specific Volts AC, Hertz, and Wattage requirements). We recommend this equipment be on a dedicated and protected circuit. Failure to wire properly will void the warranty and may result in damage to the machine. It is Gold Medal Products Co.'s recommendation that

this machine be plugged directly into a wall outlet. The use of extension cords is not recommended due to safety concerns, and may cause sacrificed and/or reduced performance. Make sure cord is located to prevent a trip hazard or unit upset.

Receptacle Wiring Diagram for NEMA 14-50 (Domestic)

A certified electrician must follow the IMPORTANT instructions below for installation of the NEMA 14-50 Receptacle (Gold Medal Item No. 82920) provided with the unit.

If the receptacle is wired incorrectly, the heat elements/kettle and other electrical components could be at 208 or 240 V potential instead of the needed 120 V, resulting in excessive temperatures in the heat elements (i.e.: kettle) and possible fire, and/or damage to electrical components.

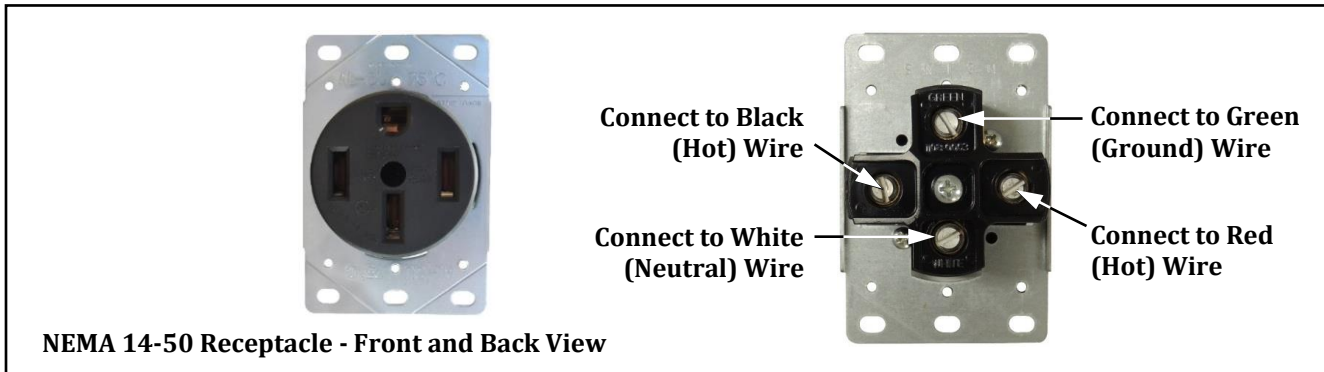

Receptacle Wiring Diagram (for Export Units – except Australia)

A certified electrician must supply and install the required wall receptacle for this unit, follow the IMPORTANT instructions shown.

This unit is designed to operate on single phase, 16 AMP, 4 wire supply. All electrical components in this machine are 230 V. If the receptacle is wired incorrectly, the heat elements/kettle and other electrical components could be at 400 V potential instead of the needed 230 V, resulting in excessive temperatures in the heat elements (i.e.: kettle) and possible fire, and/or damage to electrical components.

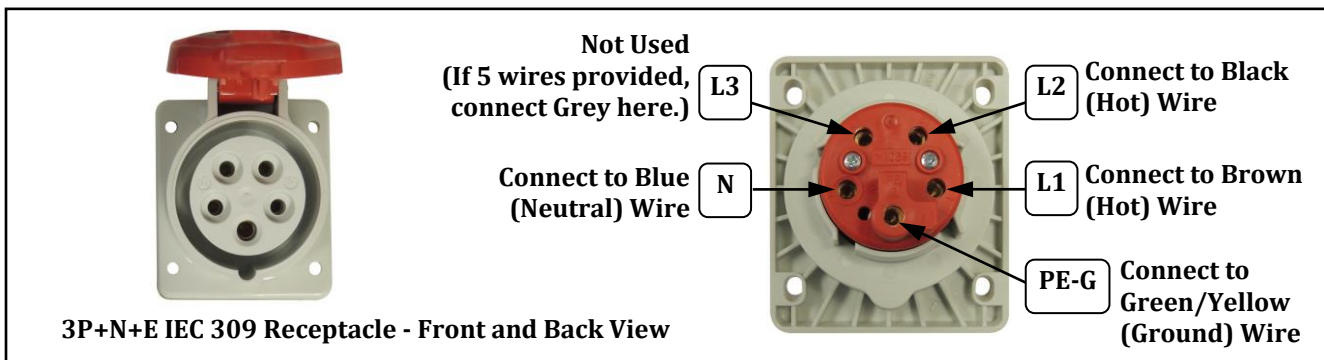

Before You Plug In Machine

1. Make sure all machine switches are OFF before plugging equipment into receptacle.
2. Make sure wall outlet can accept the grounded plugs (where applicable) on the power supply cord.
3. The wall outlet must have the proper polarity. If in doubt, have a competent electrician inspect the outlet and correct if necessary.
4. **DO NOT** use a grounded to un-grounded receptacle adapter (where applicable).
5. Install unit in a level position.

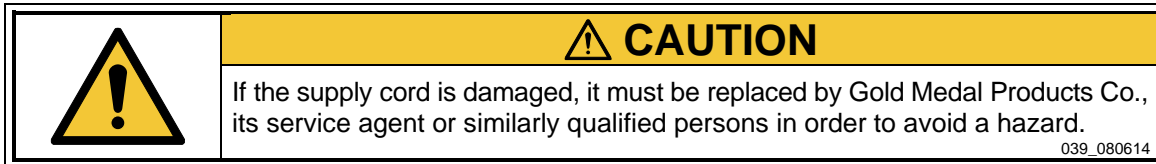

Oil Dispense Installation



This popcorn machine was adjusted, inspected, and tested before it left the factory.

To connect and calibrate the oil dispense system to this popper; refer to the Bucket Pump (Gold Medal Item No. 2114) or Bag-in-a-Box (Gold Medal Item No. 2257) Instruction Manual included with the unit.

The proper amount of oil for the 52oz. unit is between 13oz. to 17oz.

To check for proper amount of oil, and assure oil is liquid; dispense a test amount into a measuring cup.

OPERATING INSTRUCTIONS

CONTROLS AND THEIR FUNCTIONS

LIGHT SWITCH

Turns on all the lights, interior and dome, on your popcorn machine.

POPCORN CONDITIONER SWITCH

Operates the blower in the corn storage area, keeps popcorn fresh and crisp.

KETTLE HEAT SWITCH

Operates the heating elements in the popping kettle.

KETTLE MOTOR AND EXHAUST SWITCH

Operates both the kettle agitator motor, and the exhaust blower. The exhaust blower is only required when popping corn.

OIL SYSTEM MASTER SWITCH

Sends power to the oil pump. (Either the Bucket Pump or Bag-in-a-Box models) The warmer/blower on the oil pump is activated, as well as the heated line kits (If provided / purchased separately). The warmer/blower on the oil pump will keep coconut popping oil liquid if the doors on the base are kept closed. It may be desirable to keep this switch on at night, if you have problems keeping the coconut oil liquid. Coconut oil will congeal at temperatures below approximately 76° F [24° C]. (Reference the Instruction Manual for the oil dispense unit.)

“RED” OIL DISPENSE PUSH BUTTON SWITCH

When pushed, this button switch will dispense the pre-set amount of oil into the kettle. (Reference the Instruction Manual for the oil dispense unit to program the oil dispense volume.)

YELLOW LIGHT & AUDIBLE SIGNAL (LOAD – DUMP)

Alerts the operator to:

1. Load the corn and oil *or*
2. Dump the popped corn from the kettle *or*
3. Turn off the kettle heat switch if they are done popping corn

PASS THRU SWITCHES (IF EQUIPPED)

Has double switches for the kettle heat, motor, and oil on the front side and the operator side of popper.

FLEXI-POP SWITCH (IF EQUIPPED)

Changes energy to kettle for the load switch from 52 oz to 32 oz. It will automatically adjust the oil amount on the 2257D model of oil pump. (Reference the Instruction Manual for the oil dispense unit.)

SALT-SWEET SWITCH (IF EQUIPPED)

Changes the temperature setting to 50°F lower for the sweet option.

POPPING CORN

Popping Corn (Standard)

1. Turn on all Switches (except Flexi-Pop and Salt-Sweet if equipped.)
2. When popping with coconut oil, be sure the oil is liquid. Dispense oil into a measuring cup first (oil should be between 13 oz. to 17 oz.), and then use that oil for the first popping cycle.
3. When the kettle is ready (about 5-8 minutes), the Yellow Light and Audible Signal will turn on. Lift the kettle lid and pour in 52 oz. of corn (use the supplied corn cup) and 4 tablespoons (1/4 cup) of Flavacol. Close lid.
4. Press the RED oil pump button. The proper amount of oil is pumped into the kettle. The Light and Signal will turn off.
5. When the popcorn has completed popping, the Light and Signal will turn on. Dump the Popcorn.

NOTE: The signal "To Dump" was factory set based on our popcorn and oil. If the signal occurs before or after the popping has stopped, the signal timing must be adjusted (reference the Electronic Temperature Control section).

6. On the final kettle of corn, turn the "KETTLE HEAT" switch off just as the lids are forced open by the popping corn. This saves electricity, and helps eliminate smoke and odor after you have stopped popping.

Popping Corn (Flexi-Pop - If Equipped)*

1. Turn on all Switches (except Salt-Sweet if equipped.)
2. When popping with coconut oil, be sure the oil is liquid. Dispense oil into a measuring cup first (should be between 8 oz. to 10.5 oz.), and then use that oil for the first popping cycle.
3. When the kettle is ready (about 5-8 minutes), the Yellow Light and Audible Signal will turn on. Lift the kettle lid and pour in 32 oz. of corn (use the supplied smaller corn cup) and 2 tablespoons (29.6 cc) of Flavacol. Close lid.
4. Press the RED oil pump button. The proper amount of oil is pumped into the kettle. The Light and Signal will turn off.
5. When the popcorn has completed popping, the Light and Signal will turn on. Dump the Popcorn.

NOTE: The signal "To Dump" was factory set based on our popcorn and oil. If the signal occurs before or after the popping has stopped, the signal timing must be adjusted (reference the Electronic Temperature Control section).

6. On the final kettle of corn, turn the "KETTLE HEAT" switch off, just as the lids are forced open by the popping corn. This saves electricity, and helps eliminate smoke and odor after you have stopped popping.

Popping Corn (Sweet - If Equipped)*

1. Turn on all Switches (except Flexi-Pop if equipped.)
2. When popping with coconut oil, be sure the oil is liquid. Dispense oil into a measuring cup first (should be between 13 oz. to 17 oz.), and then use that oil for the first popping cycle.
3. When the kettle is ready (about 5-8 minutes), the Yellow Light and Audible Signal will turn on. Lift the kettle lid and pour in 52 oz. of corn (use the supplied corn cup.) Close lid. Wait approximately 30 to 45 seconds, then add 26 oz. of Glaze Pop or Sugar. When using sugar, we recommend the use of Compound "S" to help keep the kettle clean.
4. Press the RED oil pump button. The proper amount of oil is pumped into the kettle. The Light and Signal will turn off.
5. When the popcorn has completed popping, the Light and Signal will turn on. Dump the Popcorn.
NOTE: The signal "To Dump" was factory set based on our popcorn and oil. If the signal occurs before or after the popping has stopped, the signal timing must be adjusted (reference the Electronic Temperature Control section).
6. On the final kettle of corn, turn the "KETTLE HEAT" switch off just as the lids are forced open by the popping corn. This saves electricity, and helps eliminate smoke and odor after you have stopped popping.

Remember (For all Popping Modes):



If the Yellow Load - Dump light is turned on and the Signal is sounding *one of the* following actions should be taken:

1. Load the corn and oil **or**
2. Dump the popped corn from the kettle **or**
3. Turn off the kettle heat switch if you are done popping corn

When you are finished popping, make sure "KETTLE HEAT" and "KETTLE MOTOR" switches are turned "OFF".

NEVER LEAVE THE HEAT ON WHEN YOU ARE NOT POPPING!

Care and Cleaning

	 DANGER
	<p>Machine must be properly grounded to prevent electrical shock to personnel. DO NOT immerse in water. DO NOT clean appliance with a water jet or steam cleaner. Always unplug the equipment before cleaning or servicing. 025_051321</p>

	 WARNING
	<p>To avoid serious burns, DO NOT touch the kettle while it is hot! 028_082715</p>

Good sanitation practice demands that all food preparation equipment be cleaned regularly (only use non-toxic, food grade cleaners).

For surfaces needing further cleaning or degreasing, Watchdog Stainless Cleaner (Item No. 2088) or Watchdog Concession Equipment Degreaser (Item No. 2580) is available for use accordingly. For any cleaning products used, follow the manufacturer's instructions on the product. **DO NOT use oven cleaners or abrasive materials** as they will damage parts of machine.

Note: It is extremely important to follow all cleaning procedures, otherwise parts damage and equipment failure will result. The warranty does not cover parts that are damaged due to improper cleaning.

Daily Kettle Cleaning Instructions

1. Turn machine OFF and unplug it.

CAUTION: A hot kettle will cause burns if you touch it. Allow kettle to cool at least 1 hour before attempting to clean. DO NOT use ice or water to cool down a hot kettle! Severe kettle damage will result and steam burns may occur!
2. When cool, wipe **outside** of kettle clean using a clean, soft cloth and Gold Medal Watchdog Stainless Cleaner (Item No. 2088). **DO NOT** use oven cleaners or abrasive materials as they will damage the kettle.
3. Mix 2 tablespoons (29.6 ml) of Gold Medal's Heat'n Kleen (Item No. 2095) in 1 gallon (3.8 L) of water.
4. Only pour enough of the Heat'n Kleen pre-mixed solution into the kettle to fill it 1/2 inch (12.7 mm) deep (it is not necessary to use the entire gallon at once).
5. Plug in the unit.
6. Turn kettle heat ON. When solution starts to boil, turn kettle heat OFF.
7. Allow kettle to cool at least 1 hour, then unplug unit.
8. Dump solution into a bucket, do not spill any in the interior of machine.
9. Rinse kettle interior with clean water and a clean cloth.
10. Dump any water remaining into a bucket (do not spill any in the interior of machine), then wipe the kettle interior clean with a clean dry cloth.

For an extra dirty kettle, the process may be repeated; or, after turning kettle heat OFF, allow solution to sit in kettle overnight. The next morning, finish the cleaning steps.

11. A Clean-In-Place Hook is located behind the kettle support arm (on operator side). This feature safely holds the kettle in place for cleaning purposes and allows access to hard to reach places without removing the kettle. To remove the lid and agitator assembly, tilt kettle into the dump position, and swing the hook into position (see image below).
12. With unit OFF and unplugged, use a clean SLIGHTLY damp cloth (wring ANY EXCESS water from cloth before use) and wipe the kettle lead cord clean. **DO NOT get moisture into the kettle lead-in cord, severe damage will result.**
13. After kettle cleaning, check to be sure the crossbar fasteners are securely tightened.

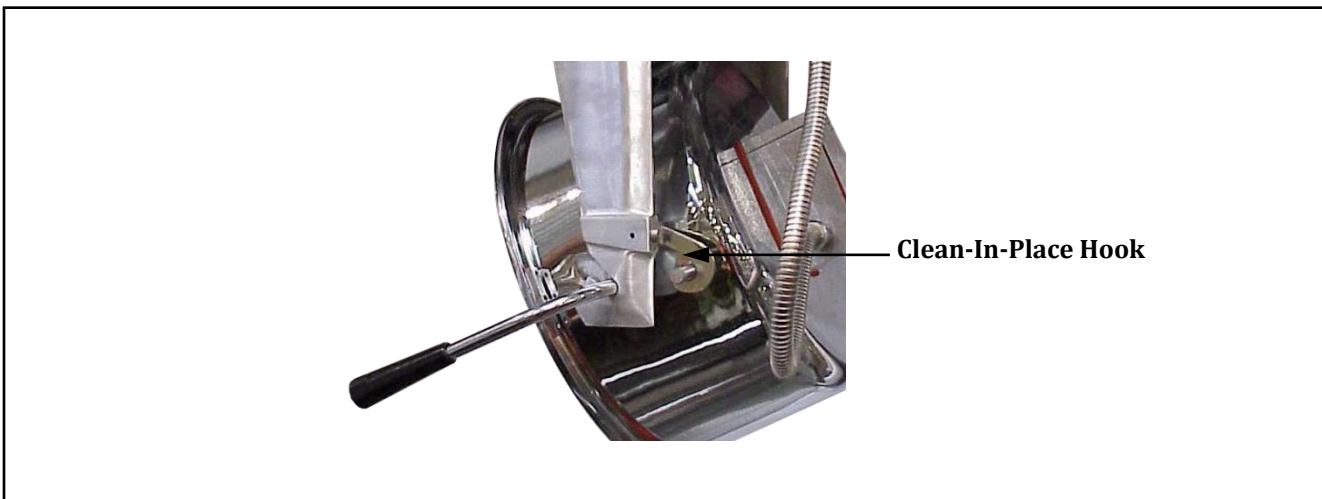

Daily Unit Cleaning Instructions

1. Turn machine OFF, unplug unit and allow it to cool before attempting to clean.
2. Remove any remaining popcorn.
3. Remove all pans/accessories and take them to the sink to clean with soap and water, then rinse and dry.
4. Clean under corn pan to remove all popcorn bits and seeds with a vacuum as needed, then wipe the area with a clean dry cloth to remove any grease.
5. Wipe clean the area above the corn pan and exterior surfaces using a clean, SLIGHTLY damp cloth to remove any grease from the glass and cabinet (cloth may be SLIGHTLY dampened with soap and water, then wipe again with clean water to remove any remaining cleaner).
6. Clean glass panels with glass cleaner. Gold Medal Watchdog Glass Cleaner (Item No. 2588) is recommended.
Ammonia cleaners will damage plastic doors/panels. Only use a non-ammonia cleaner, such as Gold Medal Watchdog Glass Cleaner (Item No. 2588).
7. Reinstall the clean and dry pans/accessories.

Sanitizing the Tubing and Pump

Reference the Oil Dispense Unit manual for oil system cleaning instructions.

Filter Cleaning

The popper is equipped with an efficient and durable filtration system. The first mesh filter should be cleaned on a daily basis, and the two internal filters should be cleaned weekly to maintain maximum efficiency. Follow the steps below for proper filter cleaning:

Step 1: Daily Filter Cleaning

Turn unit OFF and allow it to cool before removing any filters.

Remove the first Mesh Filter, and clean it each day after use. This filter can be removed without taking off the filter cover. See Step 3 for instructions on cleaning the Mesh Filter.

Step 2: Weekly Filter Cleaning

Loosen the 2 screws on the filter cover plate, on the ceiling inside the popper. Remove the cover, the Bag Filter, and the 2 Mesh Filters.

Step 3: Clean the bag filter and mesh filters in warm soapy water, then rinse. Let dry overnight, then reinstall.

CAUTION: It is important to keep the filters clean, to let the exhaust system do its job.

Clean first Mesh Filter daily.

Loosen
2 Screws

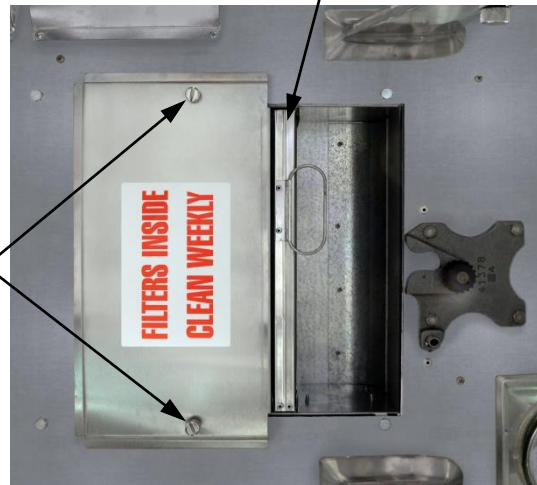

Oil Mist Bag Filter



(2) Metal Mesh Filters

Weekly Clean the Crisper/Blower Filter (if equipped)

Follow the directions below each week to clean the crisper/blower filter.

1. Turn machine OFF, unplug unit and allow it to cool before attempting to clean.
2. Lift off the corn pan to view the blower assembly.
3. Remove front grid holding the filter, then lift filter out and clean using warm soapy water (or replace if needed). Rinse thoroughly and allow to dry, before reinstalling.

Clean the Crisper/Blower Compartment (Qualified Service Personnel Only)



The blower compartment MUST be inspected/cleaned every 3-4 months by Qualified Service Personnel to maintain proper operation.

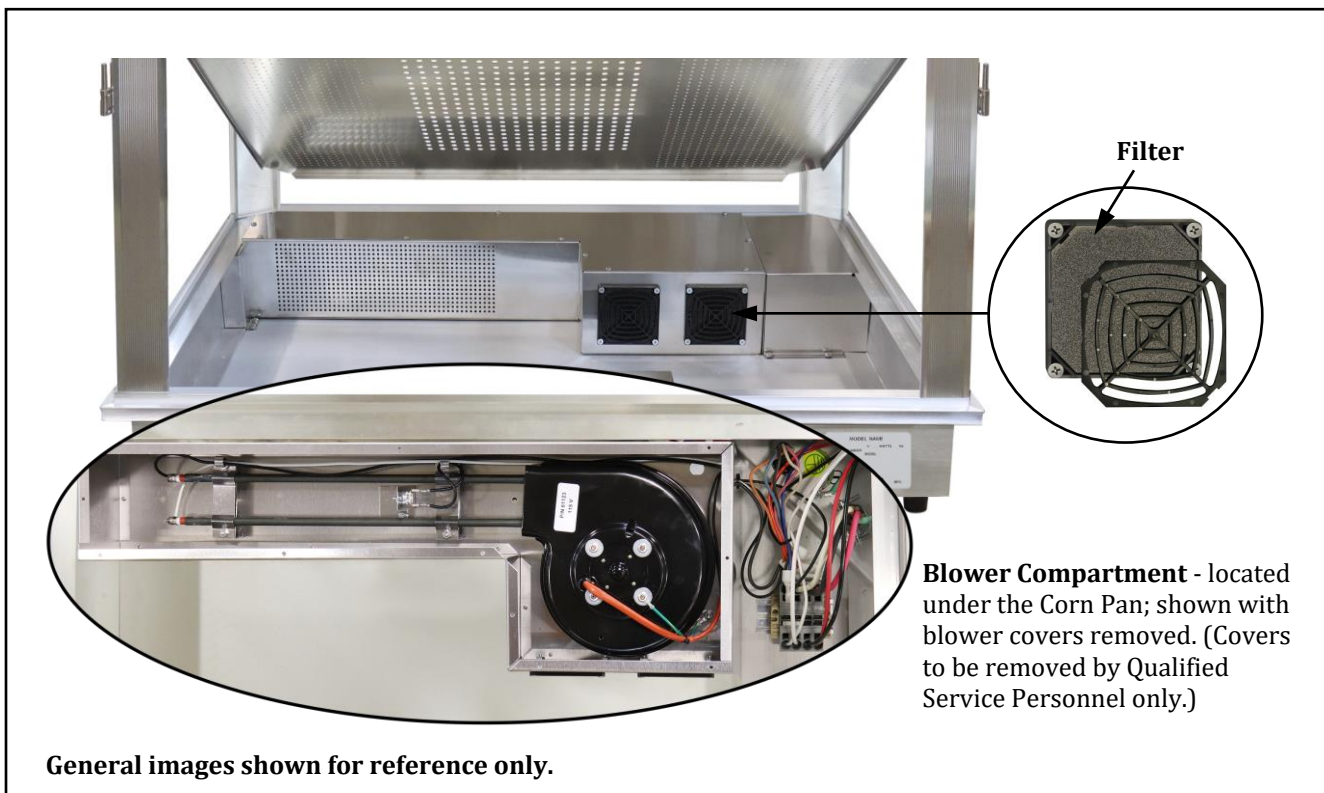

1. Turn machine OFF, unplug unit and allow it to cool before attempting to clean.
2. Lift off the corn pan to view the blower assembly.
3. Remove the blower cover and if required, carefully clean the blower compartment, and underneath the element with a vacuum only (reference image shown).
4. After cleaning, reassemble blower cover and corn pan.







___THE FOLLOWING SECTIONS ARE FOR QUALIFIED SERVICE PERSONNEL ONLY___

MAINTENANCE INSTRUCTIONS

	 DANGER
	<p>Machine must be properly grounded to prevent electrical shock to personnel. Failure to do so could result in serious injury, or death.</p> <p>Make sure all machine switches are in the OFF position before plugging the equipment into the receptacle. Keep cord and plug off the ground and away from moisture. Always unplug the equipment before cleaning or servicing.</p> <p>DO NOT immerse any part of this equipment in water.</p> <p>DO NOT use a water jet or excessive water when cleaning.</p> <p style="text-align: right;">008_012221</p>

	 DANGER
	<p>Improper installation, adjustment, alteration, service, or maintenance can cause property damage, injury, or death. Any alterations to this equipment will void the warranty and may cause a dangerous condition. This appliance is not intended to be operated by means of an external timer or separate remote-control system. NEVER make alterations to this equipment. Read the Installation, Operating, and Maintenance Instructions thoroughly before installing, servicing, or operating this equipment.</p> <p style="text-align: right;">014_020416</p>

	 WARNING
	<p>No user serviceable parts inside. Refer servicing to qualified service personnel.</p> <p style="text-align: right;">011_051514</p>

	 CAUTION
	<p>THE FOLLOWING SECTIONS OF THIS MANUAL ARE INTENDED ONLY FOR QUALIFIED SERVICE PERSONNEL WHO ARE FAMILIAR WITH ELECTRICAL EQUIPMENT. THESE ARE NOT INTENDED FOR THE OPERATOR.</p> <p style="text-align: right;">027_010914</p>

ELECTRONIC TEMPERATURE CONTROL (Domestic)

Operation

The temperature control is factory set to stop the power to the kettle when the thermocouple reaches setpoint. This is also the ideal point to dump the popped corn out of the kettle. On the first start-up, this is the ideal time to load the corn and oil. Therefore, if the Kettle Heat Switch is turned ON and the buzzer is sounding, **one** of the following actions should be taken:

- Load the corn and oil **or**
- Dump the popped corn from the kettle **or**
- Turn OFF the Kettle Heat Switch if you are finished popping corn.

Adjustment of Electronic Control

This unit has an electronic kettle control with 2 thermocouples (TC), one for control and one for limit. There are no mechanical thermostats in this kettle.

There are (4) factory adjustments on the control:

1. Control Setpoint Temperature – This is factory set, **DO NOT adjust**.
2. Signal to Dump – If you want the signal to dump to be a little sooner or later, you can adjust the Kettle Dump potentiometer (see image below). Turn clockwise (CW) to signal sooner, counterclockwise (CCW) to signal later.
3. The patented Overshoot circuit is tuned for the kettle, **DO NOT adjust** this potentiometer.
4. The Audible Signal to Dump has three options; full volume, half volume, no sound (yellow light only). Adjustments are made by jumper positions (see image below). The unit is shipped with full volume.

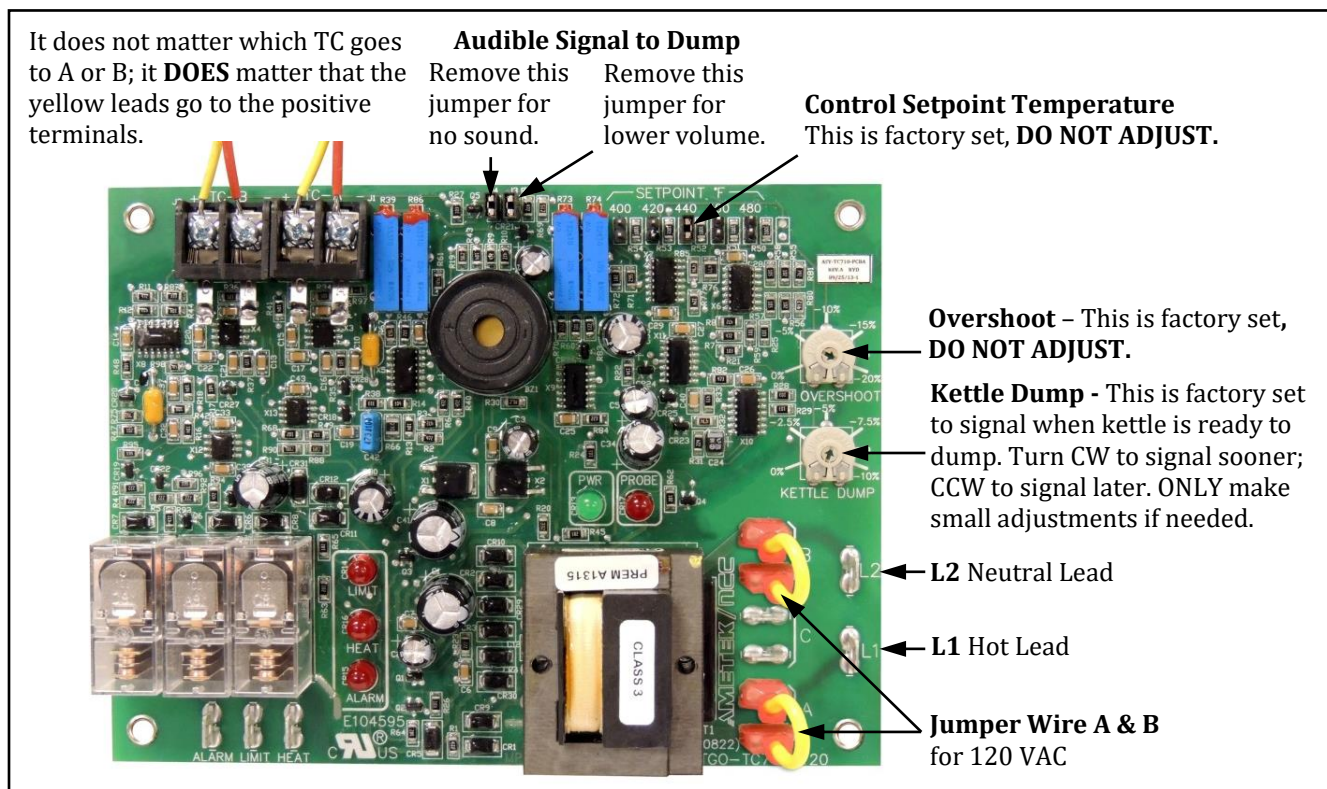

Qualified service personnel only please see Appendix A, Service Bulletin 0074

ELECTRONIC TEMPERATURE CONTROL (Export)

Operation

The temperature control is factory set to stop the power to the kettle when the thermocouple reaches setpoint. This is also the ideal point to dump the popped corn out of the kettle. On the first start-up, this is the ideal time to load the corn and oil. Therefore, if the Kettle Heat Switch is turned ON and the buzzer is sounding, **one** of the following actions should be taken:

- Load the corn and oil **or**
- Dump the popped corn from the kettle **or**
- Turn OFF the Kettle Heat Switch if you are finished popping corn.

Adjustment of Electronic Control

This unit has an electronic kettle control with 2 thermocouples (TC), one for control and one for limit. There are no mechanical thermostats in this kettle.

There are (4) factory adjustments on the control:

5. Control Setpoint Temperature – This is factory set, **DO NOT adjust**.
6. Signal to Dump – If you want the signal to dump to be a little sooner or later, you can adjust the Kettle Dump potentiometer (see image below). Turn clockwise (CW) to signal sooner, counterclockwise (CCW) to signal later.
7. The patented Overshoot circuit is tuned for the kettle, **DO NOT adjust** this potentiometer.
8. The Audible Signal to Dump has three options; full volume, half volume, no sound (yellow light only). Adjustments are made by jumper positions (see image below). The unit is shipped with full volume.

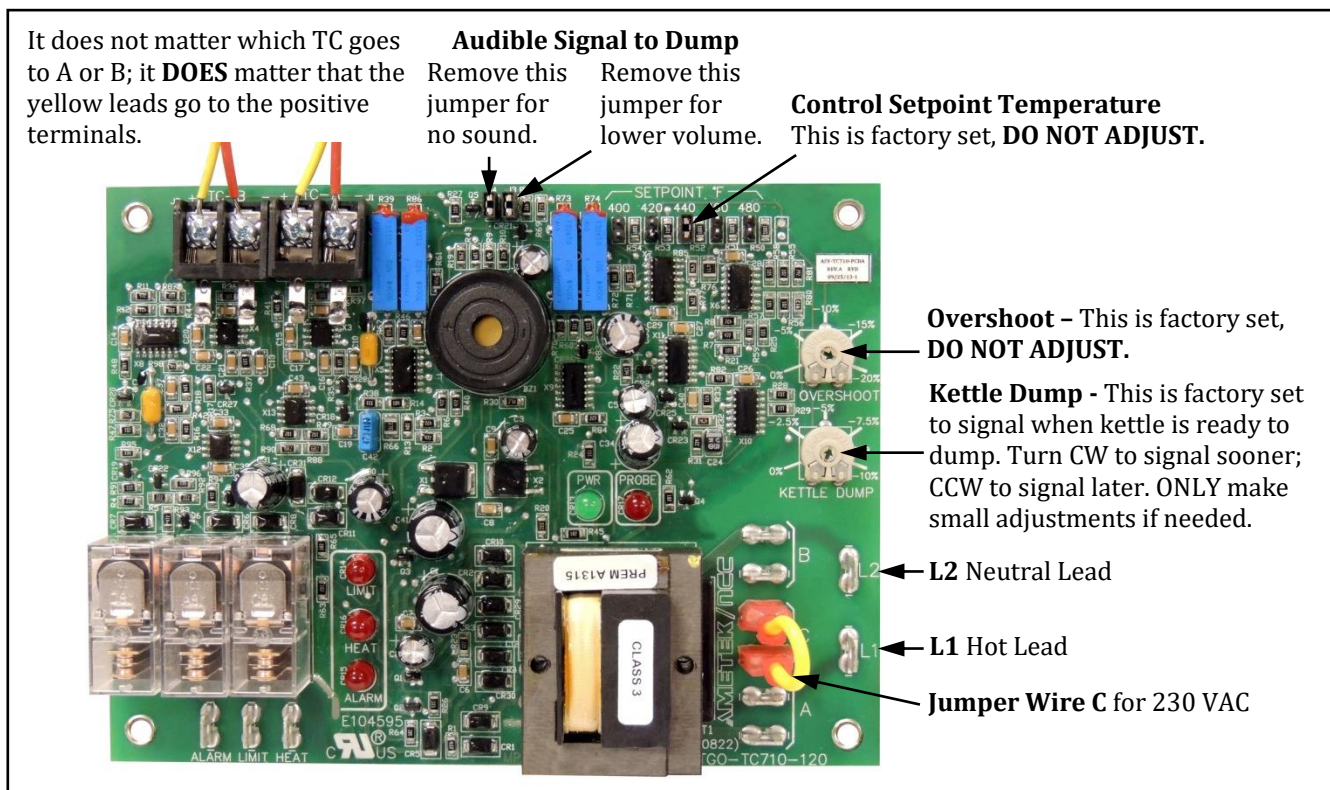

Qualified service personnel only please see Appendix A, Service Bulletin 0074

TROUBLESHOOTING

LONG POPPING CYCLES

If your pop cycle is longer than 4 minutes, it can be the result of several things:

- A. **LOW VOLTAGE** - If the machine is operated on low voltage, this could cause the kettle not to reach the proper operating temperature. Voltage for each leg, with kettle turned on, must be at least 110v.
- B. **INADEQUATE SUPPLY LINES** - Inadequately sized electrical supply lines, in addition to being a fire hazard, would also prevent the kettle from reaching the proper operating temperature. Check with a qualified electrician.
- C. **INFERIOR CORN** - Inferior quality corn would result in longer popping cycles. Use only top quality hybrid popcorn from reputable suppliers. Even then, if you let your corn pick up moisture or dry out, your popping cycles will be slow.

KETTLE DOES NOT HEAT

Before you go any further, make sure the kettle lead-in cord is plugged in, and the **kettle shunt trip breaker** is not tripped. **(See Motor Plate Assy. Figure 4, Item 4.11)** The shunt trip breaker may trip during transit, if the machine has been handled in a rough manner. If the breaker is re-set - then trips again - contact a service technician for inspection/repair before going further.

- A. **KETTLE HEAT SWITCH** - Check the voltage to and from the "KETTLE HEAT" switch, and if the switch is defective replace it.
- B. **CONTROL** - A defective thermocouple lead will cause the kettle not to heat. Check for good connections from the kettle to the control.
- C. **MAIN RELAY. (See Motor Plate Assy. Figure 4, Item 4.6)**

MOTOR WILL NOT TURN AGITATOR

WARNING! If the kettle agitator shaft is not rotating, **DO NOT** pop corn. Adjust the clearance between the kettle bottom and the stir blade to 1/32" (use a dime). Loosen the set screw in the collars above and below the crossbar and adjust the agitator shaft as necessary. Then re-tighten the set screws in the collars.

OIL PUMP DOES NOT DELIVER OIL TO KETTLE

If the pump is operating but oil is not dispensed, the oil may be solid in the oil lines.
If the pump is not operating at all, see the pump manual for instructions.

ORDERING SPARE PARTS

1. Identify the needed part by checking it against the photos, illustrations, and/or parts list.
2. Use only approved replacement parts when servicing this unit.
3. When ordering, please include part number, part name, and quantity needed.
4. Please include your model number, serial number, and date of manufacture (located on the machine nameplate/data plate) with your order.
5. Address all parts orders to:

Parts Department
Gold Medal Products Co.
10700 Medallion Drive
Cincinnati, Ohio 45241-4807

Or, place orders by phone or online:

Phone: (800) 543-0862
(513) 769-7676
Fax: (800) 542-1496
(513) 769-8500
E-mail: info@gmpopcorn.com
Web Page: gmpopcorn.com

Replacing Broken Glass

If you accidentally break a panel of glass, it can be replaced very easily. Gold Medal Products Co. does not ship glass. It can be obtained from a local glass shop and always purchase tempered glass.

Where To Find Parts

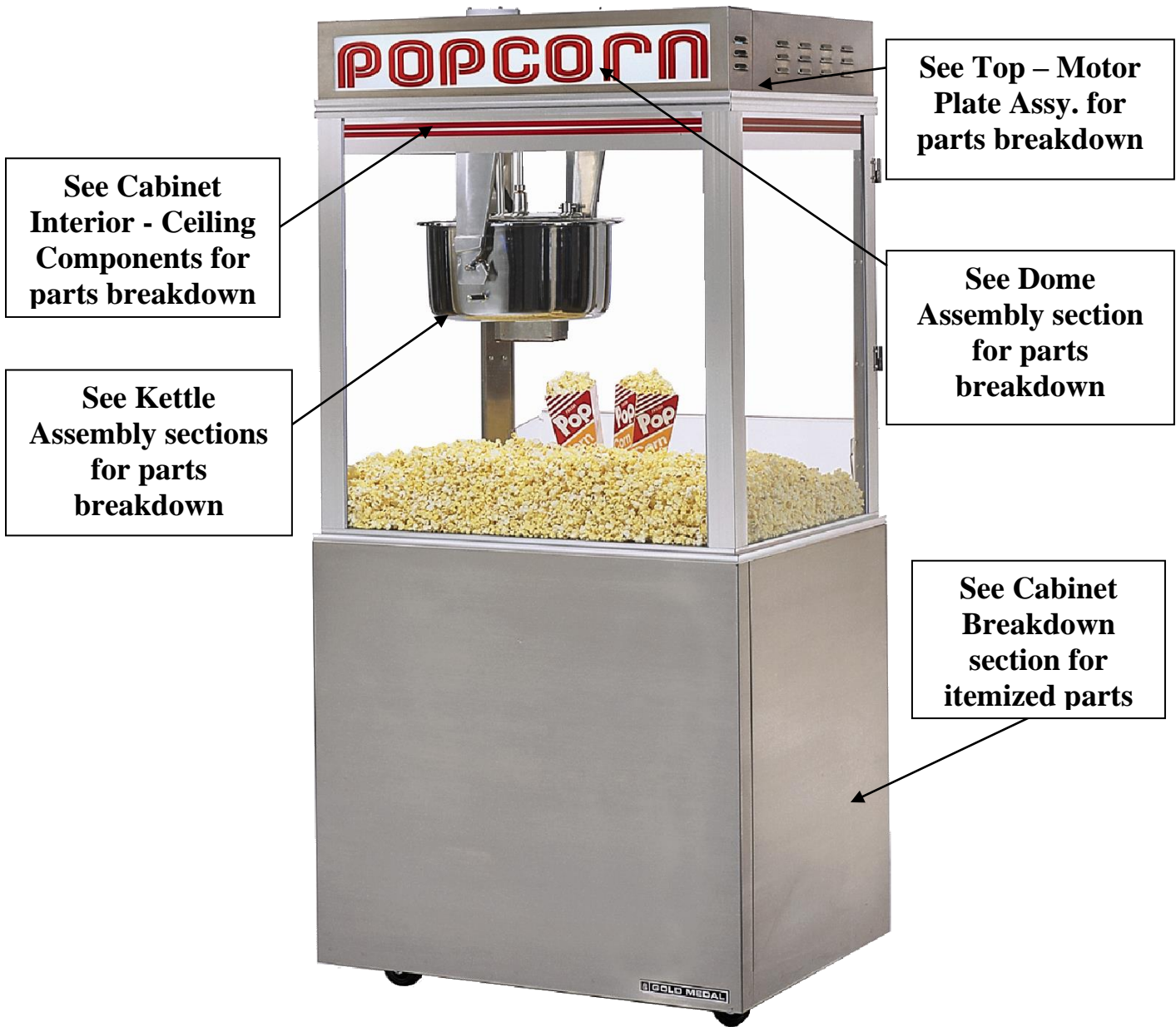

Dome – LED Lighted Sign Assembly

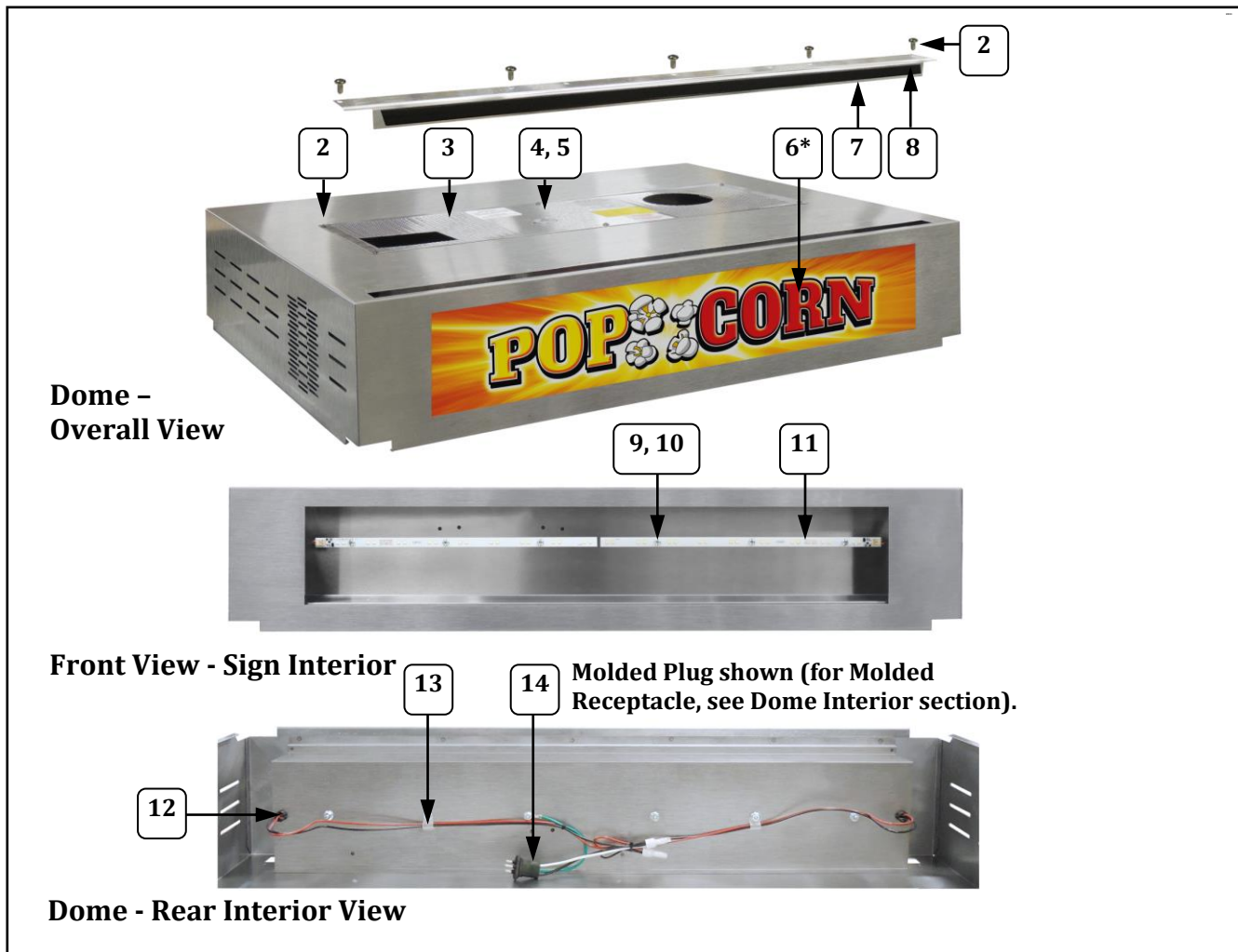

Item	Part Description	Part Number
		LED Models
1	N/A	
2	SCREW #8-32X3/8 PAN HD PH	74141
3	POG INSPECTION COVER	116269
4	1/4-20 X 1 HHC Gr2 ZINC	41903
5	FENDER WASHER	82634
6	POPCORN SIGN	111871
7	SUPPORT ANGLE, DOME	41503
8	SPONGE STRIPPING (sold by the foot)	82431
9	8-32 X 3/8 PH PAN W/SEMS	42227
10	8-32 HEX M/S NUT	74149
11	LED STRIP COOL WHITE	55379
12	BUSHING, SNAP .500 IN	47236
13	CABLE CLAMP	87219
14	MOLDED PLUG	47726

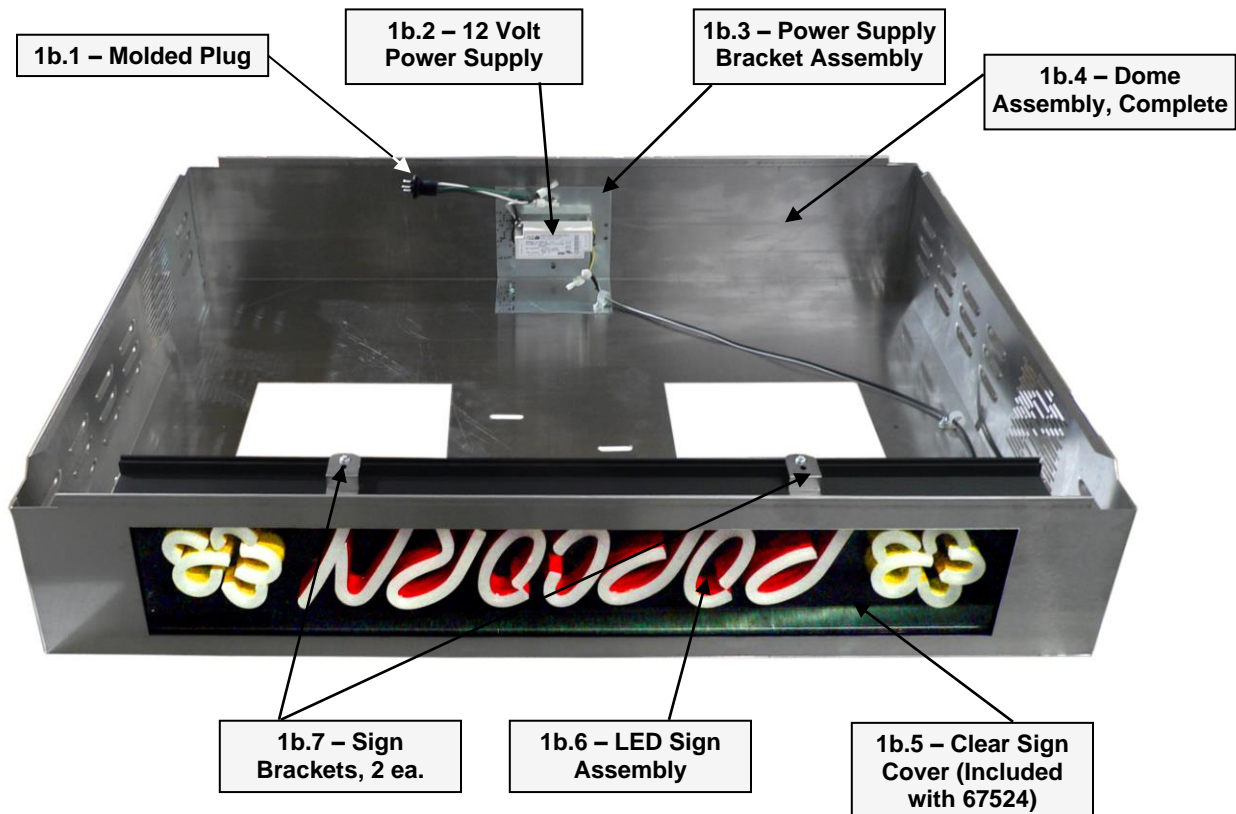

Figure 1b – Dome Assembly, LED/Neon Light

Item	Part Description	Part Number
1b.1	Molded Plug	47726
1b.2	12 Volt Power Supply	55231
1b.3	Power Supply Bracket Assembly	55233
1b.4	Dome Assembly, Complete	48560
1b.5	Clear Sign Cover (Included with 67524)	67418
1b.6	LED Sign Assembly	67524
1b.7	Sign Brackets, 2 ea.	67488

Cabinet Breakdown

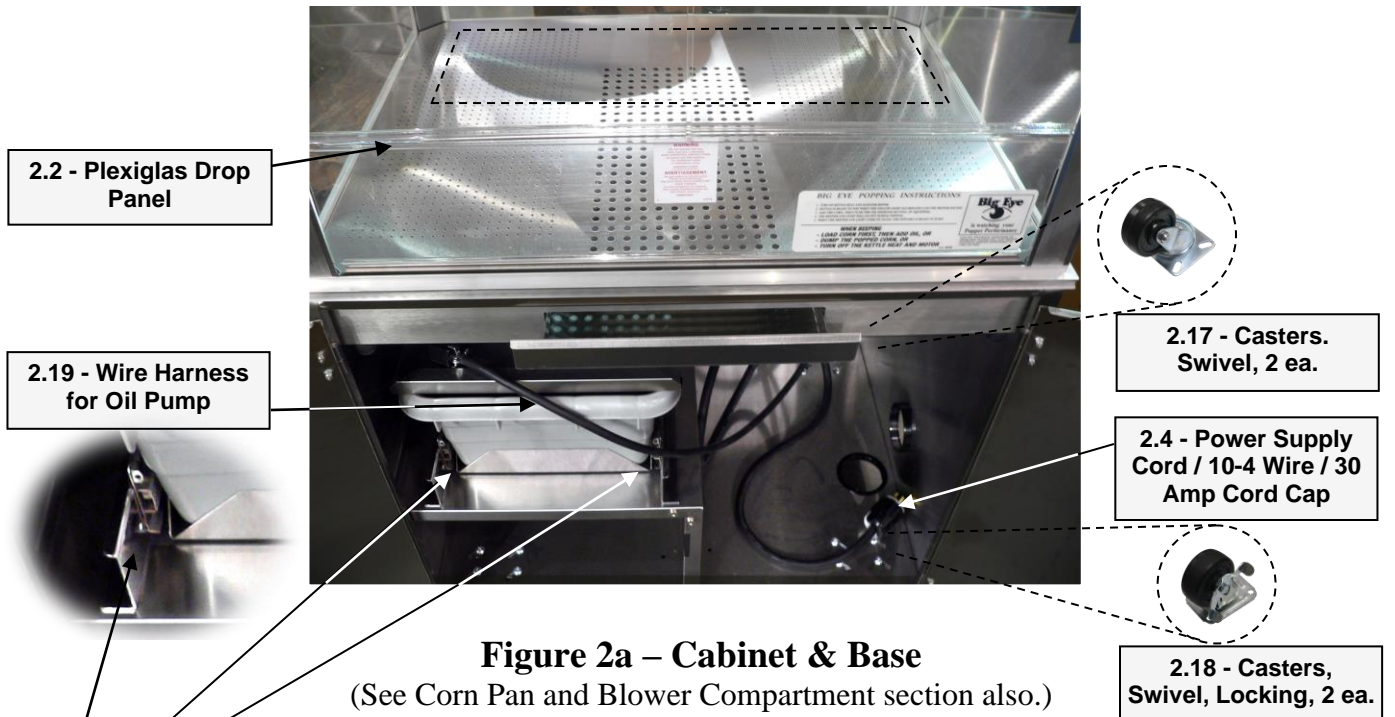



Figure 2c – Cabinet Drawer Slides

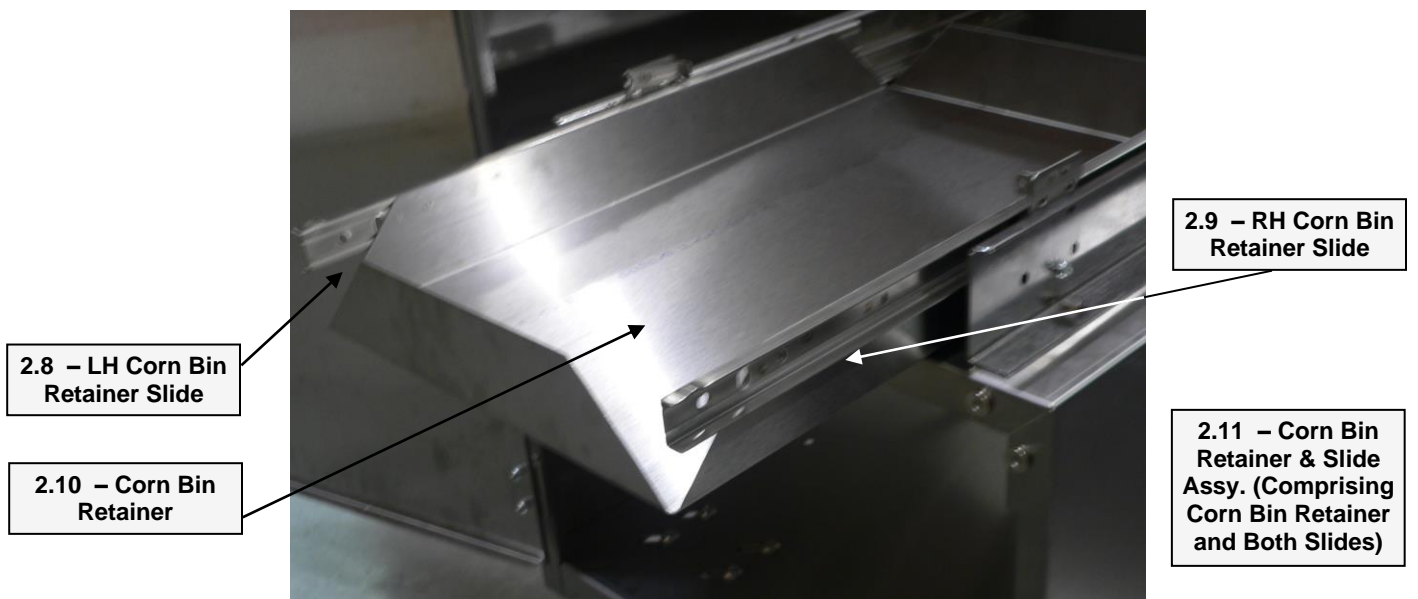

Figure 2d – Corn Bin Retainer & Drawer Slides

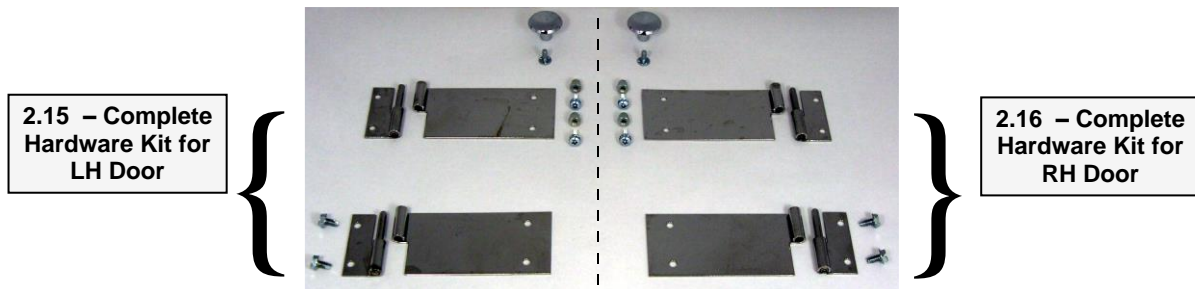
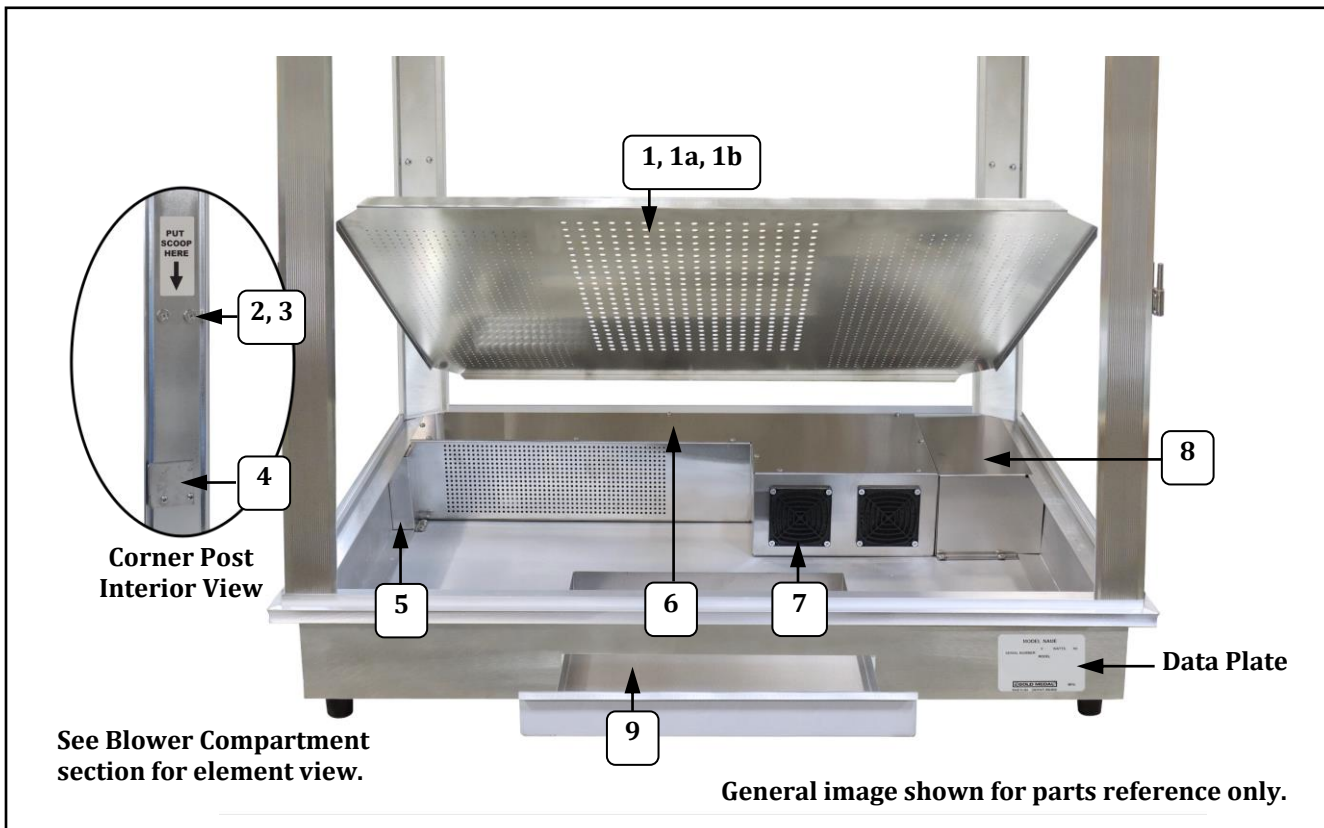

Figure 2f – Door Hardware Kits

Item	Part Description	Part No.
2.1	N/A	
2.2	Plexiglas Drop Panel	61126
2.3	N/A	
2.4	Power Cord Assembly	82260
2.5	Plexiglas Doors (Doors <u>DO NOT</u> come predrilled for hardware)	61129
2.6	LH Cabinet Drawer Slide	46512
2.7	RH Cabinet Drawer Slide	46511
2.8	LH Corn Bin Retainer Slide	41237
2.9	RH Corn Bin Retainer Slide	41217
2.10	Corn Bin Retainer	41686
2.11	Corn Bin Retainer & Slide Assy. (Retainer + LH & RH Slides)	41661
2.12	N/A	
2.13	N/A	
2.14	N/A	
2.15	Complete Hardware Kit for LH Door	47054
2.16	Complete Hardware Kit for RH Door	47055
2.17	Swivel Casters, 2 ea.	37513
2.18	Swivel Casters, Locking, 2 ea.	37514
2.19	Wire Harness for Oil Pump	41499

Cabinet Interior – Corn Pan View



Item	Part Description	Part Number
		(Non-Deep Well Models)
1	CORN SCREEN BASE	115424
1a	CORN SCRNS INS W/HNDL .375	115422
1b	CORN SCRNS INS W/HNDL .5	115423
2	MAGNET USES 8 FLT HD SC	50013
3	8-32X5/8 FL HD PH MS	20067
4	SLIDE BRACKET DROP PANEL	61137
5	CHAFF BLOCK	100703
6	TOP PLATE	63550
7	FILTER AND GUARD ASSY	63707
8	ELECTRICAL COVER	100702
9	OLD MAID PAN	100701

Blower Compartment – Element View

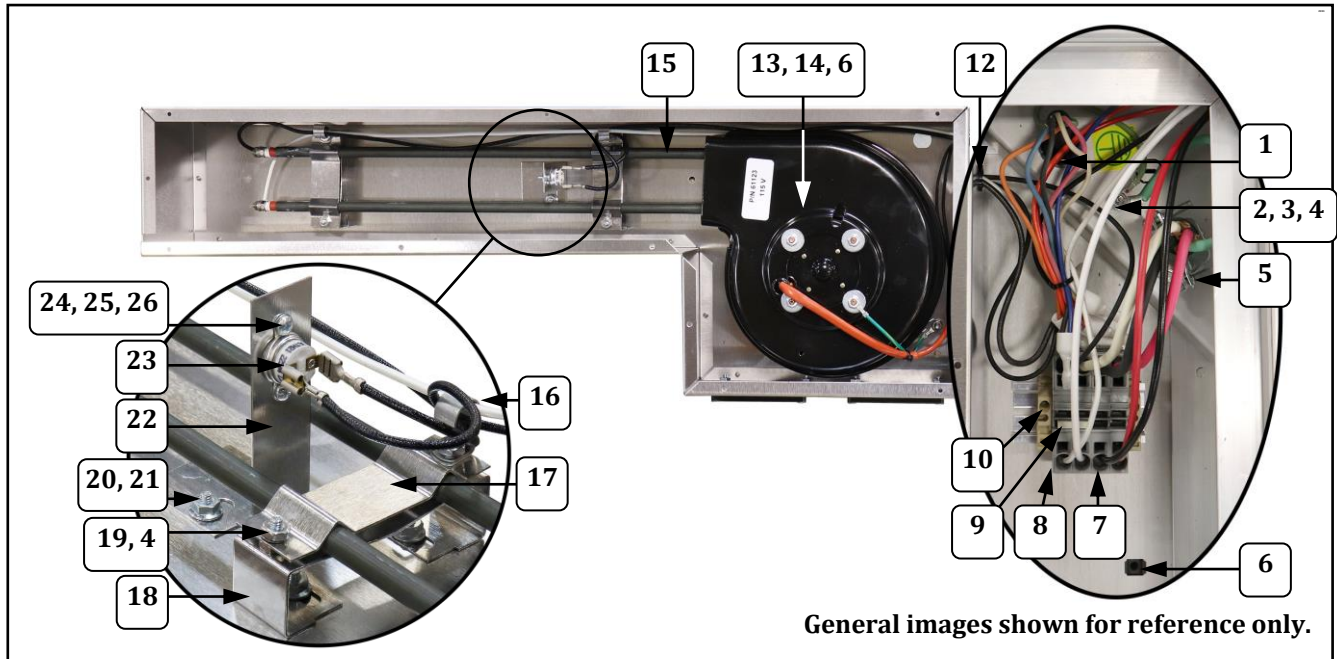

Item	Part Description	Part Number
		Countertop Series
1	STRAIN RELIEF SR-31-2	41735
2	8-32 X 1/2 PH PAN W/SEMS	47124
3	WASHER #8 INTERNAL TOOTH	74150
4	HEX NUT #8-32 STAINLESS	89129
5	STRAIN RELIEF	82227EX
6	#10-24 CAGE NUT	76081
7	TERM BLOCK, 6AWG, 2POS	118024-062
8	ENDPLATE, 6AWG, 2POS	118024-062E
9	JUMPER, 6AWG, 2-WAY	118024-062J
10	END BRACKET-DIN	118023
11	N/A	
12	BUSHING, SNAP .500 IN	47236
13	BLOWER	61123
14	SCREW, 10-24 X 3/4 HXHD (fastens blower)	41314
15	HEAT ELEMENT, 800W	61128
16	U CLIP	55215
17	HEATER CLAMP	61133
18	HEATER MOUNT	61134
19	8-32 X 1/2 PH PAN W/SEMS	47124
20	8-32 X 1/2 PHIL PN M/S SS	42226
21	8-32 SERRATED FLANGE NUT	61151
22	THERMOSTAT MOUNTING BRACKET	55500
23	WARMER THERMOSTAT	55496
24	6-32 X 3/8 PH PAN HD M/S	38087
25	WASHER #6 INTERNAL TOOTH	76188
26	6-32 ZINC PLATED HEX NUT	38005

Cabinet Interior – Ceiling Components

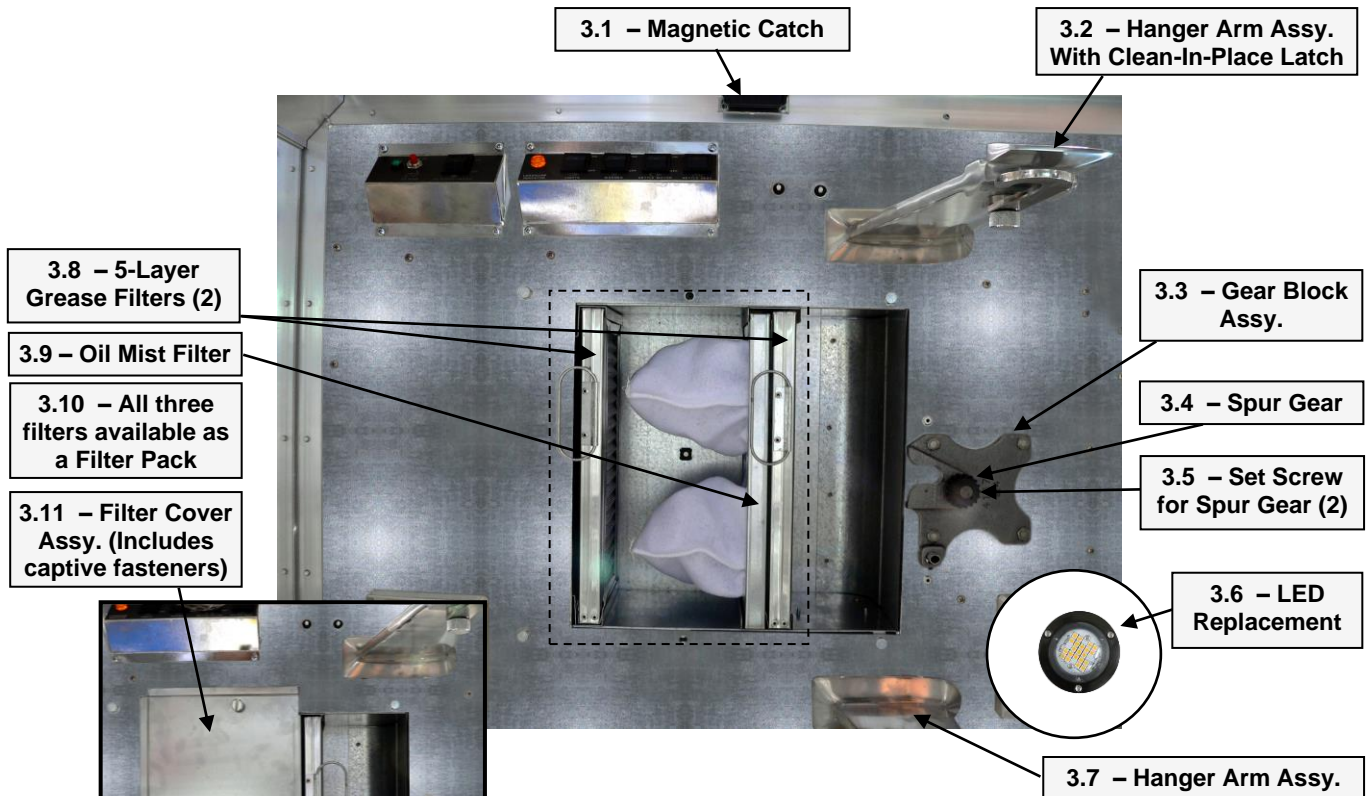

Figure 3a – Showing Filter Set

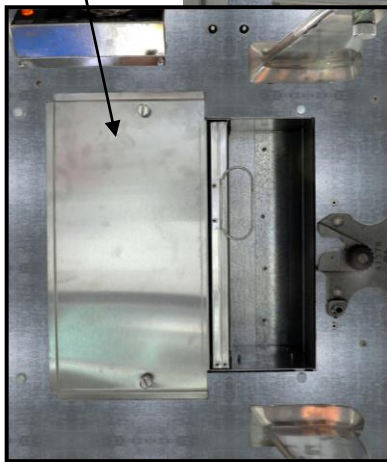

Figure 3b – Filter Cover Installed

Item	Part Description	Part No.
3.1	Magnetic Catch	47561
3.2	Hanger Arm Assy. With Clean-In-Place Latch	48908
3.3	Gear Block Assy.	41432
3.4	Spur Gear	41380
3.5	Set Screw for Spur Gear (2 ea. 10-32 x 3/16)	41742
3.6	LED Replacement	100544
3.7	Hanger Arm Assy.	48907
3.8	5-Layer Grease Filters (2)	41250
3.9	Oil Mist Filter	41169
3.10	Filter Pack - 2 ea. 5-Layer Grease Filter, 1 ea. Oil Mist Filter	82015
3.11	Filter Cover Assy.	41934

Top - Motor Plate Assy.

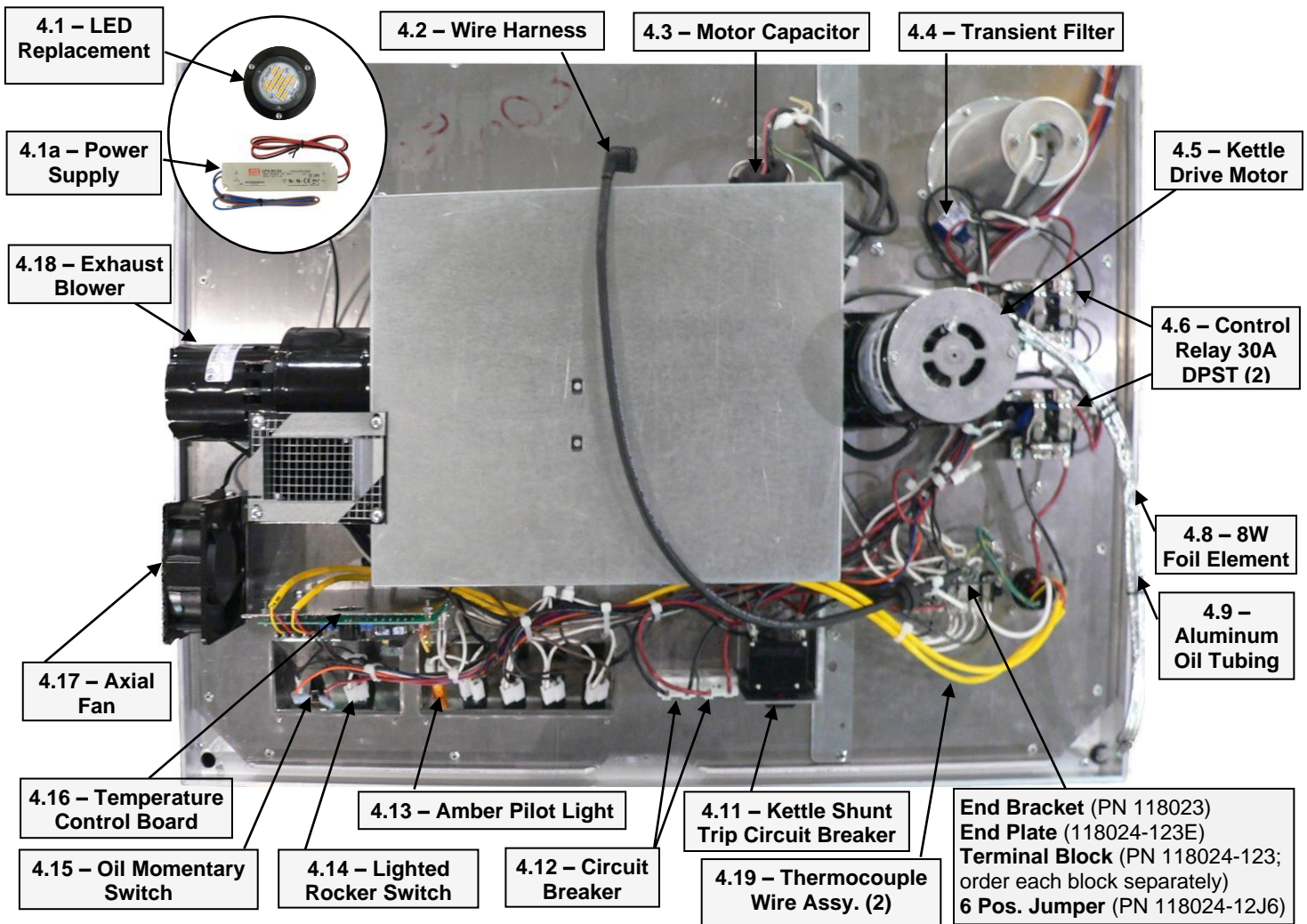

Figure 4 – Motor Plate Assembly

Item	Part Description	Part No.
4.1	LED REPLACEMENT	100544
4A	POWER SUPPLY 24VDC 20W	55394
4B	POWER SUPPLY 24VDC 60W	55586
4.2	Molded Receptacle, Warmer	41712
4.3	Motor Capacitor 7.5 uf (For Black-Bison Motor)	46107
	Motor Capacitor 10 uf (For White-Franklin Motor)	46110
4.4	Transient Filter	89087
4.5	Kettle Drive Motor	41449R
4.6	Relay, 30A DPST (2)	55219
-	-	-
4.8	8W Foil Element	41640

Item	Part Description	Part No.
4.9	Aluminum Oil Tubing (Sold By The Foot.)	41047
4.10	Terminal Block	47208
4.11	Kettle Shunt Trip Breaker	55223
4.12	Circuit Breaker, 15A	47364
4.13	Amber Pilot Light	55039
4.14	Lighted Rocker Switches	42798
4.15	Oil Momentary Switch	41031
4.16	Temperature Control Board	41001
4.17	Axial Fan	48018
4.18	Exhaust Blower	41015
4.19	Thermocouple Wire Assembly (2)	55010

52 oz. High Top Kettle (2727HT, 2727HTX) – Agitator Assy.

Reference next section for Flat Lid Kettles.

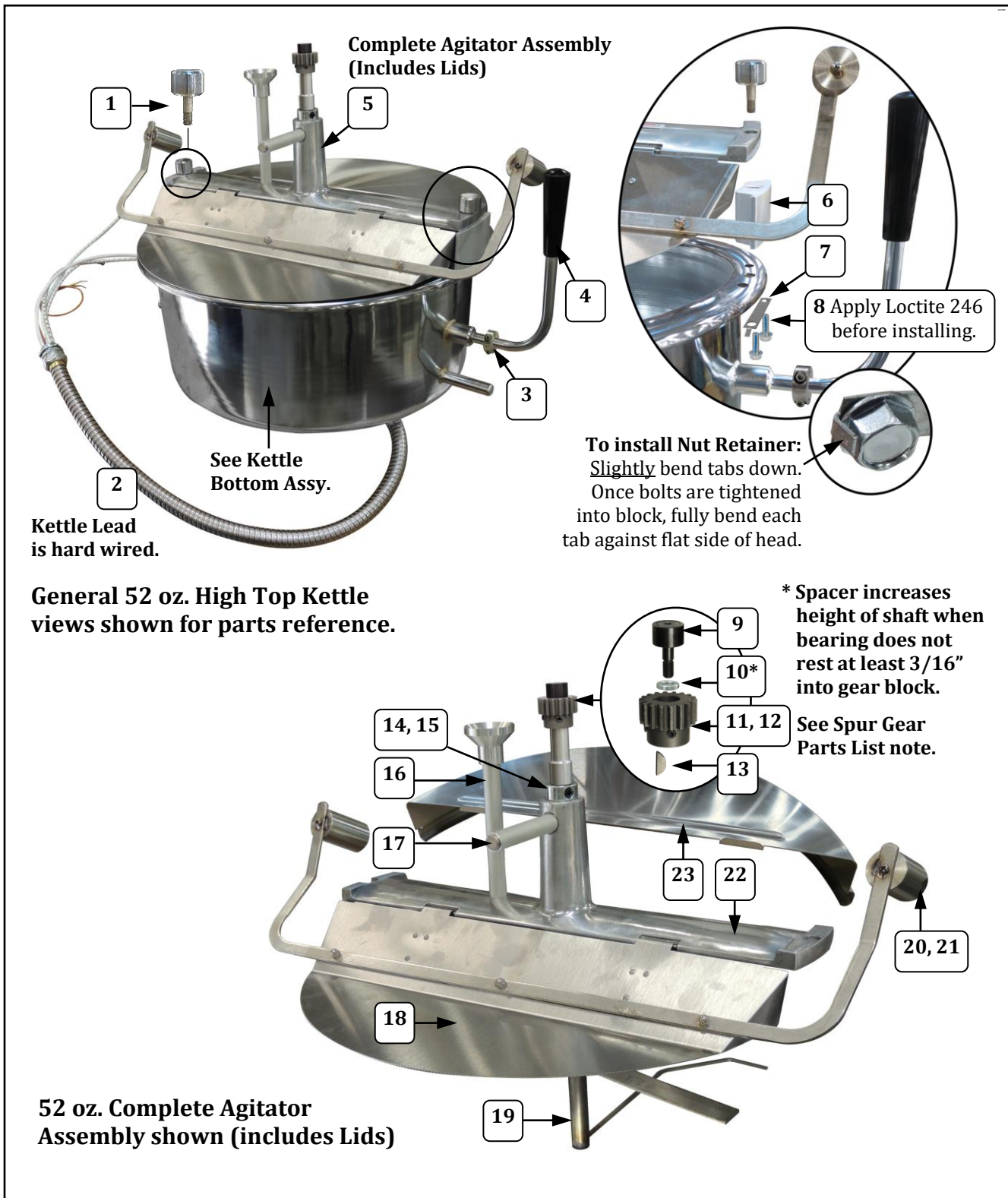

52 oz. High Top Kettle (2727HT, 2727HTX) – Agitator Assembly Parts List

Reference specific High Top Kettle Model below.

Item	Part Description	Part Number	
		2727HT	2727HTX
1	CROSSBAR FASTENER	47977	47977
2	KETTLE LEAD ASSEMBLY	55299SS	55299SS
3	1/2 IN I.D. SPLIT COLLAR	69815	69815
4	DUMP HANDLE - PLASTIC	41139	41139
5	52 OZ LID AGITATOR ASSY (Complete Assy)	48961HT	48961HT
6	TOP HAT BLOCK W/INSERT	46094	46094
7	NUT RETAINER	69315	69315
8	1/4-20 X 3/4 - 3/8 HEX (Apply Loctite 246 to screws before installing.)	106038	106038
9	BEARING CAM FOLLOWER	61225	61225
10	SPACER (used to increase shaft height when Cam Follower Bearing does not rest at least 3/16" into Gear Block)	106035	106035
11	SPUR GEAR KIT (Incls 2 gears w/set screws. Always replace Agitator Spur Gear & Kettle Drive Gear as a set.)	41380K	41380K
12	SET SCREW 1/4-20 X 3/16	47751	47751
13	WOODRUFF KEY #3 1/8 X 1/2	41730	41730
14	SHAFT COLLAR 5/8 IN	68761	68761
15	SET SCREW 5/16-18 X 3/8	74127	74127
16	OIL TUBE W/FUNNEL	47689	47689
17	MAGNET HOLDER ASSY 52 OZ (includes magnet and holder)	67926	67926
18	52 OZ REMOVABLE FRONT LID	68069	68069
19	AGITATOR WELD ASSY 52 OZ.	68121	68121
20	COUNTER WEIGHT (narrow)	82108	82108
	COUNTER WEIGHT (wide)	83114	83114
21	8-32 X 3/8 PH PAN HD M/S	42226	42226
22	CROSSBAR ASSY 52 OZ.	48965HT	48965HT
23	52 OZ FIXED REAR LID	67917	67917

52 oz. Flat Lid Kettle (2727EX) – Agitator Assembly

Reference previous section for High Top Kettles.

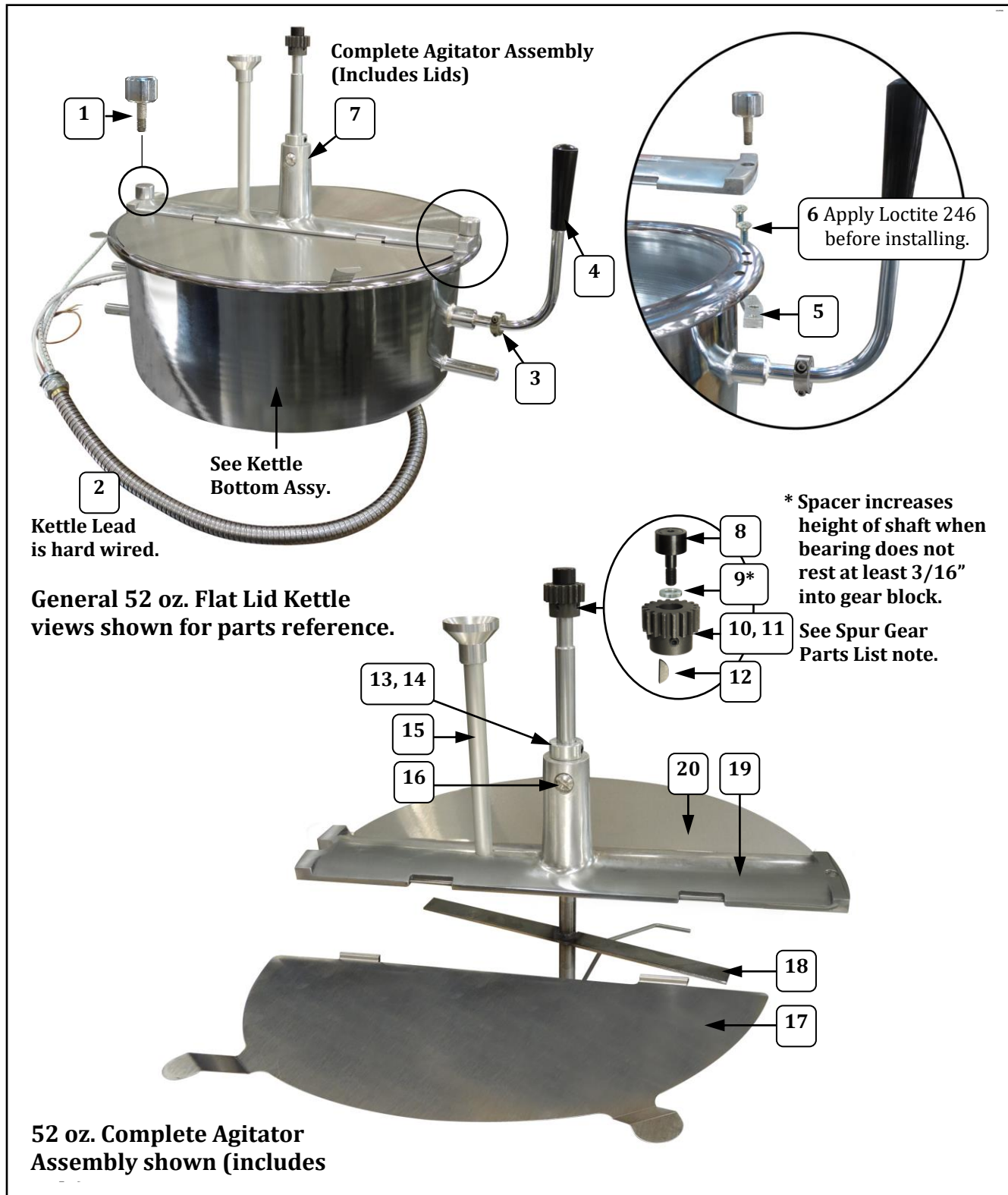

52 oz. Flat Lid Kettle (2727EX) – Agitator Assembly – Parts List

Item	Part Description	Part Number
		2727EX
1	CROSSBAR FASTENER	47977
2	KETTLE LEAD ASSY	55299SS
3	1/2 IN I.D. SPLIT COLLAR	69815
4	DUMP HANDLE PLASTIC	41139
5	THREADED BLOCK	47999
6	1/4-20 X 5/8 FLAT HEAD (Apply Loctite 246 to screws before installing.)	67947
7	LID, AGITATOR ASSY (Complete Assy)	48961
8	BEARING, CAM FOLLOWER	61225
9*	SPACER (used to increase shaft height when Cam Follower Bearing does not rest at least 3/16" into Gear Block)	106035
10	SPUR GEAR KIT (Incls 2 gears w/set screws. Always replace Agitator Spur Gear & Kettle Drive Gear as a set.)	41380K
11	SET SCREW 1/4-20 X 3/16	47751
12	WOODRUFF KEY #3 1/8 X 1/2	41730
13	SHAFT COLLAR 5/8 IN	68761
14	SET SCREW 5/16-18 X 3/8	74127
15	OIL TUBE W/FUNNEL (Oil Ready)	62771
16	THREADED PLUG	68071
17	FRONT KETTLE LID	48971
18	AGITATOR WELD ASSY	68121
19	CROSSBAR ASSY	48965
20	REAR KETTLE LID	48972

52 oz. Kettle Bottom Assembly – Parts Breakdown

Reference DOMESTIC Parts List or EXPORT Parts List for specific Kettle Model.

Form a tab UP on flat of nut to retain nut position.

Form tab DOWN.

14*
15
16
17
18

16
19, 20, 21
22
23

20, 21

Kettle Shell Bottom View

Junction Box Interior View

52 oz. Element view shown
General images shown for parts reference only. (Reference wire diagram shipped with popper for wiring.)

52 oz. Kettle Bottom Assembly (all Models) – Parts List

Reference specific DOMESTIC or EXPORT Kettle Model listed below.

Item	Part Description	Part Number	
		2727HT	2727HTX, 2727EX
	RH KETTLE BOTTOM ASSY (Complete Assembly - includes all parts listed below)	55300N	55300NX
1	HEAT TRANSFER PLATE	56120	56120
2	ELEMENT SHIM (only used as needed)	68787	68787
3	KETTLE GASKET	48958	48958
4	STUDLESS KETTLE	56118	56118
5	ELEMENT CLAMP (52 oz. Medallion)	68780	68780
6	HEX NUT 1/4-20	74133	74133
7	1/4-20 X 1.25 SET SCREW	69140	69140
8	NUT RETAINER	50190	50190
9	1/4-20 RND TOP SQ NUT	69156	69156
10	RETAINING NUT	41434	41434
11	TUBULAR ELEMENT, 1050W	48651	48651EX
12	TUBULAR ELEMENT, 1800W	48650	48650EX
13	HEAT ELEMENT, 2700W	82597	82598
14	KETTLE SHELL WELD	48959	48959
15	8-32 X 1/2 SLOTTED H W H (Screw)	49379	49379
16	JUNCTION BOX ASSEMBLY	55311	55311
17	JUNCTION BOX GASKET (between Junction Box and Cover)	40965	40965
18	JUNCTION BOX GASKET (between Kettle and Junction Box)	40963	40963
19	8-32 X 1/2 PHIL PAN M/S	47141	47141
20	WASHER #8 INTERNAL TOOTH	74150	74150
21	8-32 HEX M/S NUT	74149	74149
22	ACORN NUT #8-32	47702	47702
23	KETTLE TERMINAL BLOCK	41129	41129

Safety Labels and Accessories

The image displays eight safety labels categorized into three groups:

- Unit Labels (1-3):**
 - 1: Big Eye Popping Instructions (Big Eye logo, numbered steps 1-5, and safety warnings).
 - 2: CAUTION label with a crossed-out flame icon and text: "NEVER USE COIL HEATERS TO POP CORN. ONLY USE THE POPPER. NEVER TOUCH THE HEATERS. NEVER TOUCH THE POPPER WHEN IT IS HOT."
 - 3: KEEP MOTOR AND HEAT SWITCH "OFF" WHEN NOT POPPING CORN. (Yellow diamond warning sign).
- Kettle Lead Label (4-7):**
 - 4: FOR BETTER RESULTS, ON ARE SAFE BEING HEAT UP TO 25% MORE SALES. ALWAYS USE FLAVACOL. (Orange circular label).
 - 5: CAUTION: HOT SURFACES. ATTENTION: SURFACE TRES CHAUDE. (Triangle warning sign with flame icon).
 - 6: DO NOT CLEAN THIS MACHINE WITH "BLEACH" OR OTHER AMMONIA CLEANERS. IT WILL DAMAGE THE FINISH AND COILS. DO CLEAN WITH GOSU DREIN WATCHDOG CLEANER. (Rectangular label).
 - 7: DANGER label with multiple symbols and text: "NEVER TOUCH THE HEATERS WHEN THE POPPER IS HOT. NEVER TOUCH THE HEATERS WHEN THE POPPER IS HOT. NEVER TOUCH THE HEATERS WHEN THE POPPER IS HOT. NEVER TOUCH THE HEATERS WHEN THE POPPER IS HOT."
- Power Cord Label (8):**
 - 8: DANGER label with text: "ONLY USE PROPERLY GROUNDING RECEPTACLES. NEVER ELECTRICALLY CONNECT TO OTHER ELECTRICAL DEVICES. NEVER USE THE POWER CORD AS A ROPING DEVICE. NEVER USE THE POWER CORD AS A ROPING DEVICE. NEVER USE THE POWER CORD AS A ROPING DEVICE."

Item	Part Description	Part Number All Models
1	UNIVERSAL ELEC LABEL	105007
2	WARNING LABEL	68805
3	LABEL, KEEP SWITCH OFF	47790
4	LABEL, USE FLAVACOL	47008

Item	Part Description	Part Number All Models
5	LABEL, CAUTION HOT	38201
6	LABEL, DO NOT CLEAN	49393
7	CONDUIT WARNING LABEL	49350
8	WARNING LABEL CORD	68720

Wiring Diagram

**For wiring information, please reference
the Wiring Diagram shipped with the popper.**

GOLD MEDAL PRODUCTS COMPANY

10700 Medallion Drive
Cincinnati, Ohio 45241-4807
U.S.A.

Phone: (513) 769-7676
Fax: (513) 769-8811

SERVICE BULLETIN 0074

Date Issued – 8/23/04 revised 1/28/14

Model(s) Affected- All Poppers with NCC Electronic Temperature Control

This bulletin describes popcorn machines equipped with an Electronic Temperature Control manufactured by NCC for Gold Medal Products. There are no mechanical thermostats used with this control. The mechanical thermostats are replaced by two Thermocouple Sensors, one for the High Limit and one for Temperature Control. This model is also equipped with a beeper and an indicator light that activate when the kettle heat switch is on and the kettle is at or over the dump temperature set point.

Note: All components listed in this service bulletin are shown in Figure 1 on page 5).

Operation

The control is factory set to a temperature which stops power to the kettle when the thermocouple in the kettle reaches the set temperature. See Table 1 for a list of temperature jumper settings. There is a Kettle Dump Potentiometer that is used to set the Alarm point for loading and dumping the kettle. This potentiometer will subtract up to 10% of the set point jumper value to fine tune the alarm point. If the kettle heat switch is turned on and the beeper is sounding *one of the* following actions should be taken:

1. Load the corn and oil *or*
2. Dump the popped corn from the kettle *or*
3. Turn off the kettle heat switch if you are finished popping corn.

The High Limit Control is fixed at 550°F and cannot be adjusted.

Overshoot Potentiometer

For a **stainless steel kettle** the Patented First Time Overshoot Circuit Potentiometer is set to -20%, full clockwise (CW). DO NOT change this setting. This setting prevents the kettle from getting too hot during the first time heat up.

When power is applied to the kettle and the kettle temperature is below the first time overshoot temperature set point the power to the kettle will be turned off at the overshoot temperature. The alarm will NOT sound. The kettle will then cool to a point below the first time overshoot value and start to reheat. When the kettle reaches the alarm temperature the alarm will sound and it is time to load the kettle with corn and oil. The kettle will now operate from the alarm and jumper set points. The first time overshoot set point is based on

the power set point jumper setting. For example if the power set point jumper is set at 460°F the first time overshoot set point will be 368°F (460°F-92°F). The 92°F is 20% of the 460°F value.

Adjustment of Alarm Set Point

If you would like to have the beeper sound sooner or later than the factory setting, adjust the temperature setting as follows:

1. To sound the beeper sooner, turn the Kettle Dump pot clockwise (CW) towards the -10% mark on the control board. This will lower the alarm set point without changing the power set point jumper value. For example if Set Point jumper is set at 400°F and the Kettle Dump pot is at -5% the kettle alarm temperature will be 380 °F (400°F - 20°F), the power set point stays at 400°F. If the pot is set at 0% the alarm and power set points are the same, 400°F. If the pot is set at -10% the alarm set point is 360°F (400°F -40°F) and the power set point is 400°F. A change of 1% CW on the potentiometer will subtract about 3 seconds from the alarm set point.
2. To sound the beeper later, turn the Kettle Dump pot counterclockwise (CCW). A change of 1% CCW on the Dump potentiometer will add about 3 seconds to the alarm set point.

Adjustment of beeper Sound Level

If you would like to lower the beeper volume, remove jumper J3 shown in figure 1. To stop the beeper remove jumper J4.

Salt / Sweet Option

The control board will have two separate set point jumpers. The lower value jumper is the sweet temperature. These jumpers have wires attached to them going directly to a salt/sweet switch or a salt /sweet relay. The salt/sweet switch selects which jumper is active.

Factory Set Point Jumper Settings

Model	Temperature Salt °F	Temperature Sweet °F	Overshoot Potentiometer
Macho Pop/Pappy's	460	400	-20%
2102E Citation	440	400	-20%
52 oz. Medallion	460	420	-20%
32 Oz. Pop-O-Gold	440	400	0%
2010 Astro Pop	460	420	0%
36 oz. Cornado	440	400	-20%
48 oz. Cornado	440	400	-20%

Table 1

Trouble Shooting for Service Personnel

1. If the kettle does not heat and there are no beeper sounds, look on the heat control to see if the green PWR LED is on. The PWR LED indicates there is power to the control board. If the LED is not on, check the Heat Switch and wiring. Check for 120 VAC (230 VAC) across terminals L1 & L2.
2. If the kettle does not heat and/or the beeper sounds continuously check to be sure there is a set point jumper in one of the 6 locations. Remove the jumper and clean the pins off, sometimes the conformal coatings gets on the pins and acts as an insulator.
3. If the kettle does not heat and/or the beeper sounds continuously, look on the heat control to see if the red Probe LED is on. The Probe LED indicates there is a thermocouple problem.
 - a. If the Probe LED is **on** and the Limit & Heat LED's are **off** and the beeper is **on** there is a problem with the Heat Thermocouple, TC-B wiring. Look at the terminal blocks for a loose connection. Check the kettle wiring for a loose or broken thermocouple wire.
 - b. If the Probe and Heat LED's are **on** and the beeper is **off** there is a problem with the Limit thermocouple, TC-A wiring. Look at the terminal blocks for a loose connection. Check the kettle wiring for a loose or broken thermocouple wire.
 - c. If the Probe LED is **not on** the thermocouple connections are **OK**. If the Limit LED and Alarm LED's are **on** and the beeper is **on** check the Set Point Jumpers. Most likely the jumper has come off. If the Jumper is in place temporarily move it to a different temperature setting to see if the control then works.
4. If the kettle heats for a short time and then stops.
 - a. If the Probe, Heat and Alarm LED's are **on** and the beeper is **on** the Heat Thermocouple, TC-B is wired reverse. Check for reversed thermocouple leads, see note 2 below. If the thermocouple leads are reversed the kettle will heat up to about 240°F and stop with the Probe LED on. The leads could be reversed at either the heat control itself or the terminal block.
 - b. If the Probe and Heat LED's are **on** and the beeper is **off** the Limit Thermocouple, TC-A is wired reverse, troubleshoot as in item 3-a above. Note this is similar to 2-b above, the difference is the kettle started to heat and then quit.
5. The kettle is popping normally but the beeper does not sound, check for a missing jumper at J4.
6. Salt or Sweet temperature is not working correctly. Check to make sure both temperature set point jumpers are in place and wired correctly. Be sure the common wire for the switch or relay is connected to a bottom pin of one of the set point jumpers.

Notes:

1. Do **not** adjust the (4) painted potentiometers numbers R89, R36, R73 and R74 on the electronic heat control. If adjusted, the performance will be erratic and could result in an over temperature condition.
2. Thermocouple wire consists of (2) different wires made of different materials that are color-coded polarity. It is important that red (-) is connected to red (-), and yellow (+) is connected to yellow (+), at the lead-in plug, the receptacle, and at the electronic heat control. Note that the red lead is magnetic if you have trouble determining which is which.
3. This control includes a patented first time overshoot circuit. On power up if the kettle is below the first time overshoot temperature it is normal for the heat light to go off and the kettle to stop heating before the set dump temperature. The kettle will continue to heat as soon as the kettle temperature drops below the first time overshoot temperature.
4. The Limit, Heat and Alarm LED's indicate the state of the output relays of the temperature control board. If an output LED is lit there should be 120 VAC on the respective ¼" faston with respect to common. The main voltage to the temperature control must be wired such that the hot 120 VAC (230 VAC) is connected to L1. The L2 connection is for the neutral or common voltage wire.

If you have any questions, please feel free to call **Technical Service** or **Engineering** at **Gold Medal Products Co.** Toll Free Phone Number **1-800-543-0862**

Temperature Control Board

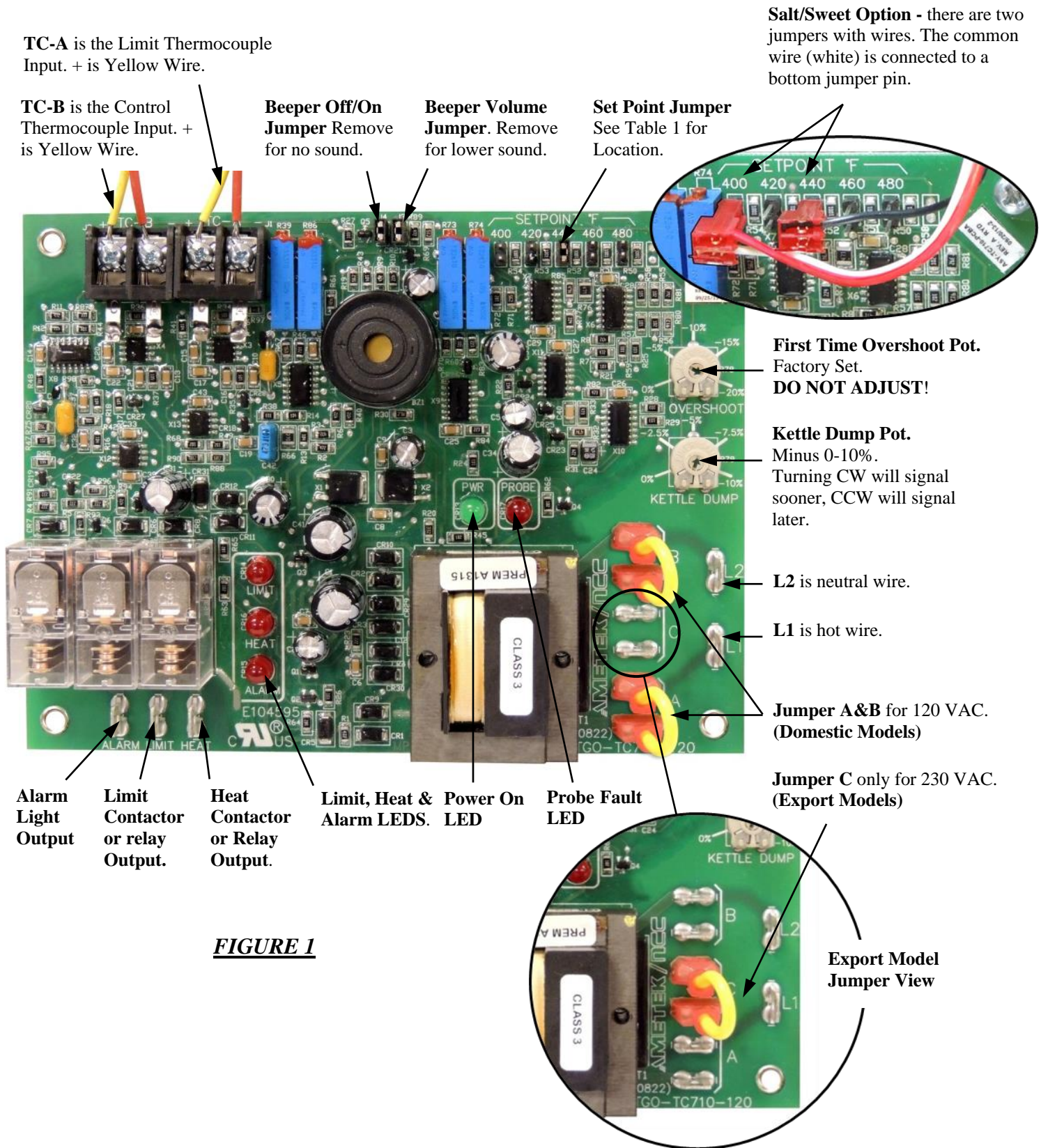

FIGURE 1

WARRANTY

Gold Medal Products Co. warrants to the original purchaser each item of its manufacture to be free of defects in workmanship and material under normal use and service. Gold Medal Products Co.'s obligation under this warranty is limited solely to repairing or replacing parts, f.o.b. Cincinnati, Ohio, which in its judgment are defective in workmanship or material and which are returned, freight prepaid, to its Cincinnati, Ohio factory or other designated point. Except for "Perishable Parts" on specific machines, the above warranty applies for a period of two (2) years from the date of original sale to the original purchaser of equipment when recommended operating instructions and maintenance procedures have been followed. These are packed with the machine. Parts warranty is two (2) years, labor is six (6) months.

THIS WARRANTY IS IN LIEU OF ALL OTHER WARRANTIES EXPRESSED OR IMPLIED, AND OF ALL OTHER OBLIGATIONS OR LIABILITIES ON OUR PART, INCLUDING THE IMPLIED WARRANTY OF MERCHANTABILITY. THERE ARE NO WARRANTIES WHICH EXTEND BEYOND THE DESCRIPTION ON THE FACE HEREOF. In no event shall Gold Medal Products Co. be liable for special, incidental or consequential damages. No claim under this warranty will be honored if the equipment covered has been misused, neglected, damaged in transit, or has been tampered with or changed in any way. No claim under this warranty shall be honored in the event that components in the unit at the time of the claim were not supplied or approved by Gold Medal Products Co. This warranty is effective only when electrical items have been properly attached to city utility lines only at proper voltages. This warranty is not transferable without the written consent of Gold Medal Products Co.

The term "Original Purchaser" as used in this warranty shall be deemed to mean that person, firm, association, or corporation who was billed by the GOLD MEDAL PRODUCTS CO., or their authorized distributor for the equipment.

THIS WARRANTY HAS NO EFFECT AND IS VOID UNLESS THE ORIGINAL PURCHASER FIRST CALLS GOLD MEDAL PRODUCTS CO. AT 1-800-543-0862 TO DISCUSS WITH OUR SERVICE REPRESENTATIVE THE EQUIPMENT PROBLEM, AND, IF NECESSARY, FOR INSTRUCTIONS CONCERNING THE REPAIR OR REPLACEMENT OF PARTS.

NOTE: This equipment is manufactured and sold for commercial use only.



GOLD MEDAL[®] PRODUCTS CO.

10700 Medallion Drive, Cincinnati, Ohio 45241-4807 USA

gmppopcorn.com

Phone: (800) 543-0862 Fax: (800) 542-1496
 (513) 769-7676 (513) 769-8500