

Pop-O-Gold

Instruction Manual









**GGOLD MEDAL**®

FUNFOOD EQUIPMENT AND SUPPLIES

Cincinnati, OH 45241-4807 USA

SAFETY PRECAUTIONS

	⚠ DANGER
	<p>Machine must be properly grounded to prevent electrical shock to personnel. Do NOT immerse the kettle, warmer, or any other part of this equipment in water. Always unplug the equipment before cleaning or servicing.</p>
	⚠ WARNING
	<p>To avoid serious burns, do NOT touch the kettle while it is hot.</p>
	⚠ WARNING
	<p>Always wear safety glasses when servicing this equipment.</p>
	⚠ WARNING
	<p>Any alterations to this equipment will void the warranty and may cause a dangerous situation. NEVER make alterations to the equipment. Make sure all machine switches are in the OFF position before plugging the equipment into a receptacle.</p>
	⚠ CAUTION
	<p>This equipment is designed and sold for commercial use only. This equipment is not to be used by the consumer in home use. Do NOT allow direct contact of this equipment by the public when used in foodservice locations. Only personnel trained and experienced in the equipment operation may operate this equipment. Carefully read all instructions before operation.</p>
	⚠ CAUTION
	<p>This machine is NOT to be operated by minors! A minor is defined by any person under the age of 18.</p>

NOTE

The information, specifications and illustrations contained in this manual represent the latest data available at time of publication. Right is reserved to make changes as required at the discretion of Gold Medal Products Company without notice.

INSTALLATION INSTRUCTIONS

INSPECTION OF SHIPMENT

Unpack all cartons and check thoroughly for any damage that may have occurred during transit. Damage claims should be filed immediately with the transportation company.

ELECTRICAL REQUIREMENTS

DOMESTIC MODELS ONLY: 120V – 208V or 120V – 240V, 60 Hz.

A 30 amp 4 wire wall receptacle is shipped with each machine. This receptacle will accept the attachment plug on the popper and must be used. Your electrician must furnish sufficient current for proper operation of your machine. We recommend this popper be on a dedicated and circuit protected line.

Note: The *Pop-O-Gold* uses both hot to neutral legs, 120V. The machine does not use the 208V or 240V hot-to-hot connection.

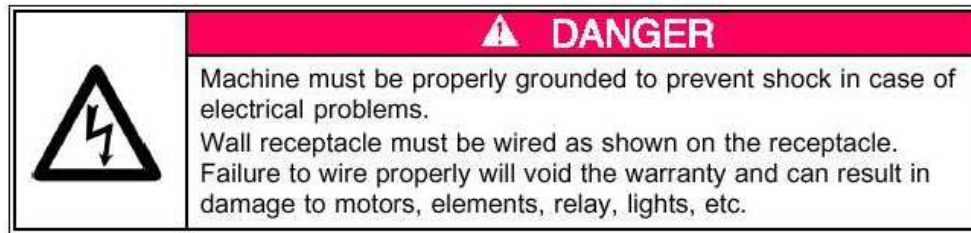

FIRE SUPPRESSION MODELS

If equipped, fire suppression components are in accordance with *ANSUL R-102* specifications. The fire suppression system is shipped empty; the machine will not operate until the system is charged and inspected by a local *ANSUL* representative. System charging is not performed by **Gold Medal®** Products.

Contact **Gold Medal®** Products Technical Support with any questions regarding the fire suppression system. Service and maintenance of the fire suppression system must be performed by an *ANSUL* certified technician.

FINAL PREPERATIONS



The popcorn machine was adjusted, inspected, and tested before it left the factory. After the machine has been installed, mount the kettle assembly in the hanger arms and plug in the kettle lead-in cord. Tighten the ring on the kettle lead-in plug.

Connect the clear oil line from the pump to the aluminum line from the popper with the supplied hose clamp. Connect the 6 pin connector from the popper to the receptacle on the oil pump. Both Bucket pump (2114E) and Bag-in-a-Box pump (2257) have the same receptacle. (See B.I.B manual)

The Bag-in-Box oil pumps are pre-calibrated before leaving the factory, however, should the oil setting need to be adjusted, see the manual for your specific model.

To check for proper amount of oil, and assure oil is liquid; dispense a shot into the measuring cup that is provided with the machine.

CONTROLS AND THEIR FUNCTIONS

(Pg. 4-5)

LIGHT SWITCH

This switch operates all the lights; interior and dome on your popcorn machine.

WARMER SWITCH

This switch operates the forced air popcorn crisping system.

KETTLE HEAT SWITCH

This switch operates the heating elements in the popping kettle.

KETTLE MOTOR AND EXHAUST SWITCH

This switch operates both the kettle agitator motor and the exhaust blower. The exhaust blower is only required when popping corn.

OIL SYSTEM MASTER SWITCH

This sends power to the oil pump. (Either the Bucket Pump or Bag-in-a-Box models) The warmer/blower on the oil pump is activated, as well as the heated line kits (If provided/purchased separately). The warmer/blower on the oil pump will keep coconut popping oil liquid if the doors on the base are kept closed. It may be desirable to keep this switch on at night, if you have problems keeping the coconut oil liquid. Coconut oil will congeal at temperatures below approximately 76° F [24° C].

RED OIL DISPENSE MOMENTARY SWITCH

When pushed, this switch will dispense the pre-set amount of oil into the kettle.

YELLOW LIGHT AND AUDIBLE SIGNAL(LOAD-DUMP)

Alerts the operator to:

1. Load the corn and oil or
2. Dump the popped corn from the kettle or
3. Turn off the kettle heat switch if they are done popping corn

FLEXI-POP SWITCH (IF EQUIPED)

This switch changes energy to kettle for the load switch from 32oz to 18oz. It will automatically adjust the oil amount on the 2257D model of oil pump. The blue light & the blue cup are for the 32oz and the red are for the 18 oz.

SALT AND SWEET SWITCH (IF EQUIPPED)

This switch changes the temperature setting to 50°F lower for the sweet option.

CONTROLS AND THEIR FUNCTIONS

(Continued)

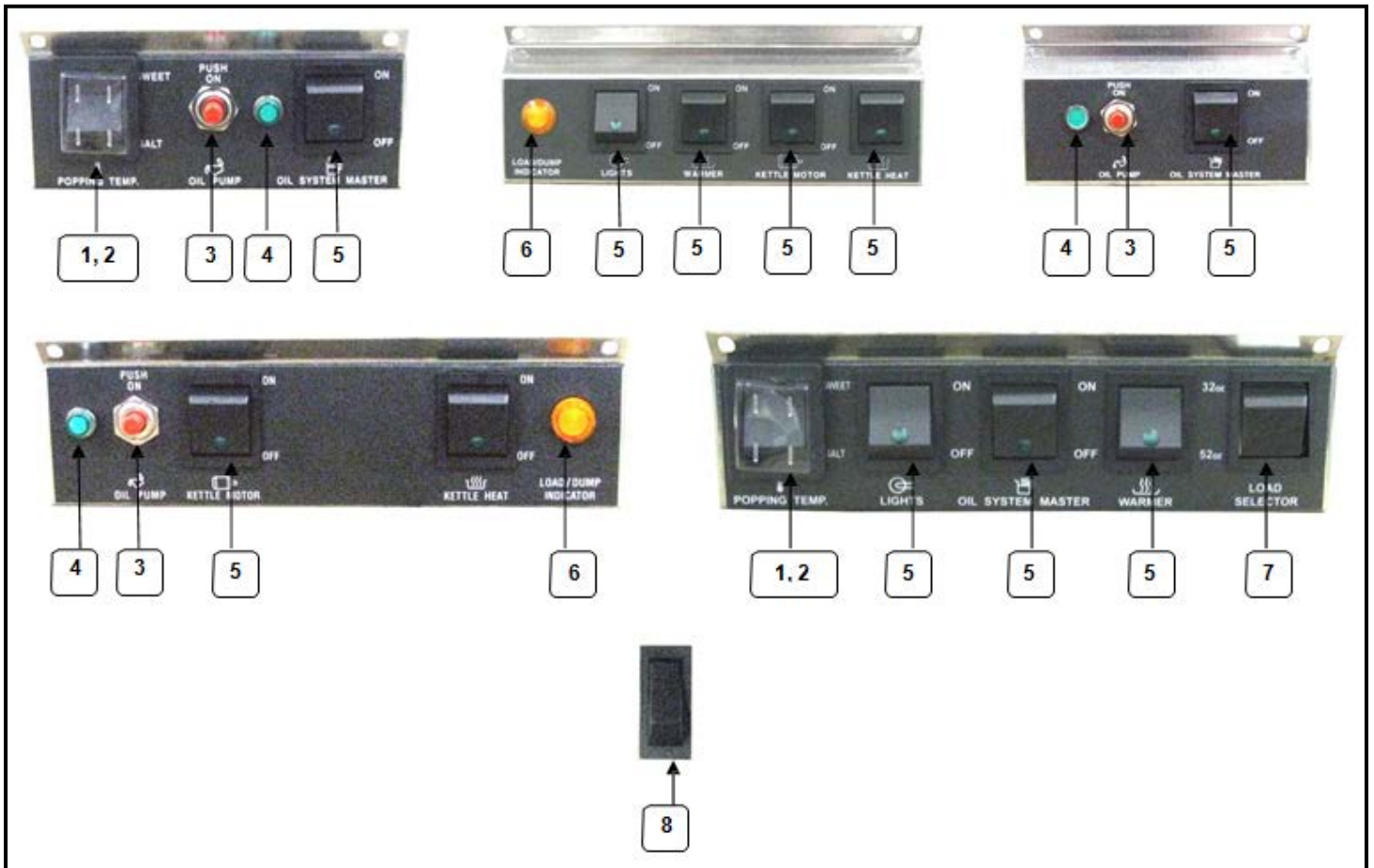

ITEM	PART NO.	PART NAME
1	55440	Salt Sweet Switch
2	48786	Switch Cover - For Salt Sweet Switch only
3	41031	Oil Momentary
4	48660	Green Pilot Light
5	42798	Lighted Rocker Switch
6	55039	Load Dump Pilot Light - Amber
7	39410	3 Position Rocker Switch - Flexi-Pop Models Only
8	55050	Switch, Rocker SPDT - Salt Sweet Only

POPPING CORN INSTRUCTIONS

STANDARD POPPING INSTRUCTIONS

1. Turn on all Switches.
2. When popping with coconut oil, be sure the oil is liquid. Dispense oil into a measuring cup first then use that oil for the first popping cycle.
3. When the kettle is ready (About 5-8 minutes), the light and audible signal will turn on. Lift the kettle lid and pour in 32 oz. of corn (Use the supplied corn cup) and 8 teaspoons of *Flavacol*. Close lid.
4. Press the *RED* oil pump button. The proper amount of oil is pumped into the kettle. The light and signal will turn off.
5. When the popcorn has completed popping, the light and signal will turn on. Dump the popcorn.
6. On the final kettle of corn, turn the *Kettle Heat* switch off just as the lids are forced open by the popping corn. This saves electricity and helps eliminate smoke and odor after you have stopped popping.

POPPING INSTRUCTIONS SWEET (IF EQUIPPED)

1. Use the switch to select sweet mode.
2. When the kettle is ready (About 5-8 minutes), the yellow light and audible signal will turn on. Lift the kettle lid and pour in 32 oz of corn and close the lid. Wait approximately 30-45 seconds, and then add 16 oz. of glaze pop or sugar. When using sugar, we recommend the use of *Compound S* (Part No. 2320) to help keep the kettle clean.
3. Press the *Red* oil pump button. The proper amount of oil is pumped into the kettle. The light and signal will turn off.
4. When the popcorn has completed popping, the light and signal will turn on. Dump the popcorn.
5. On the final kettle of corn, turn the *Kettle Heat* switch off just as the lids are forced open by the popping corn. This saves electricity, and helps eliminate smoke and odor after you have stopped popping.

NOTE: If your machine is equipped with Salt-Sweet **and** Flexi-Pop options, and you wish to pop sweet popcorn in flexi mode, follow the instructions for popping sweet corn and turn on the Flexi-Pop switch. The amounts of corn and oil will be roughly half of the standard amount in flexi mode. Pop a few test batches until you have achieved the best results, adjusting the amounts to until you reach your desired quality of popcorn.

POPPING INSTRUCTIONS FLEXI-POP (IF EQUIPPED)



1. Use load selector switch to select 32 oz or 16 oz of corn to pop. Proper amount of oil will be dispensed based on selection.
2. Follow remaining steps from popping instructions above.

NOTE: If the *Kettle Heat* switch is turned on and the signal is sounding one of the following actions should be taken:

1. Load the corn and oil
2. Dump the popped corn from the kettle
3. Turn off the kettle heat switch if you are done popping corn

When you are finished popping, make sure **KETTLE MOTOR** and **KETTLE HEAT** switches are turned **“OFF”**. **NEVER LEAVE THE HEAT ON WHEN YOU ARE NOT POPPING!**

MAINTENANCE INSTRUCTIONS

	<p style="text-align: center;">⚠ DANGER</p> <p>Improper installation, adjustment, alteration, service or maintenance can cause property damage, injury, or death. Read the Installation, Operating, and Maintenance Instructions thoroughly before installing or servicing this equipment.</p>
	<p style="text-align: center;">⚠ WARNING</p> <p>Adequate eye protection must be used when servicing this equipment to prevent the possibility of injury.</p>
	<p style="text-align: center;">⚠ CAUTION</p> <p>THE FOLLOWING SECTIONS OF THIS MANUAL ARE INTENDED ONLY FOR QUALIFIED SERVICE PERSONNEL WHO ARE FAMILIAR WITH ELECTRICAL EQUIPMENT. THESE ARE NOT INTENDED FOR THE OPERATOR.</p>

CLEANING INSTRUCTIONS

(Pg. 8-9)

DAILY KETTLE CLEANING

1. As you pop corn, wipe the kettle with a clean cloth. It is easy to keep the outside clean when the kettle is warm and the oil is not baked on.

CAUTION: The hot kettle will cause burns if you touch it with your hand.

2. Every night, mix a gallon of *Heat'n Kleen* solution (**Gold Medal®** Part No. 2095) 2 tablespoons per gallon of water. Add enough solution to fill the kettle ½" deep. Turn on the kettle heat. When the water starts to boil, turn off the heat and let it work overnight.
3. The next morning, dump the solution in a bucket and wipe the inside of the kettle with a cloth.
4. A *Clean-In-Place* hook is located behind the operator side kettle support arm. With the lids and crossbar assembly removed, just tilt the kettle to the dump position, and swing the hook into position to hold the kettle in the dumped position. This feature will help you clean the kettle.

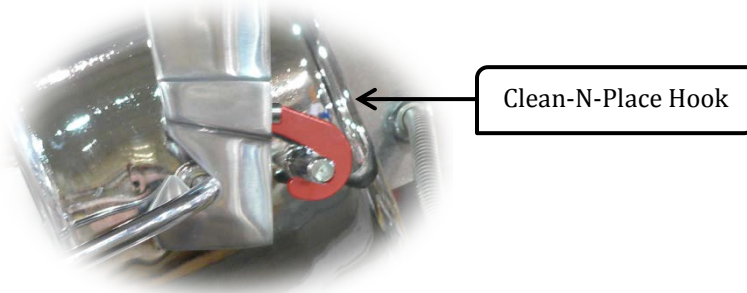

CLEAN THE POPCORN MACHINE

1. Wipe the stainless steel parts with a clean cloth and cleaner designed for stainless steel. **DO NOT** use oven cleaners, as they will damage parts of the machine.
2. Ammonia cleaners will damage the plastic doors. Use only non-ammonia cleaners, such as **Gold Medal® Watchdog Glass Cleaner** (Item No. 2588).

	⚠ DANGER
	<p>Never immerse the kettle in water. This will ruin the electrical components and automatically void the guarantee.</p>

CLEANING INSTRUCTIONS

(Continued)

WEEKLY FILTER CLEANING

1. Loosen the 2 screws on the filter cover plate on the ceiling inside the popper. Remove the cover, the bag and mesh filters. Clean the bag filter and the mesh filters in warm soapy water. Let dry overnight and reinstall.

CAUTION: Keeping the filters clean is important to let the exhaust system do its' job.

2. Check the condition of the clear oil lines and tighten or replace as required.

<i>ITEM NO</i>	<i>PART NO</i>	<i>DESCRIPTION</i>
1	41250	Metal mesh filter
2	41169	Oil Mist Bag Filter
3	82015	Filter Pack (Includes all three filters)

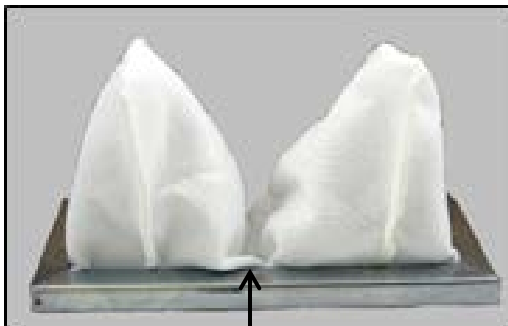

Oil Mist Bag Filter
Part No. 41169
Quantity: 1



Metal Mesh Filter
Part No. 41250
Quantity: 2

TROUBLESHOOTING

LONG POPPING CYCLES

If your pop cycle is longer than 4 minutes, it can be the result of several things:

HEATING ELEMENT - One of the heating elements in the kettle may be burned out. This would result in the kettle never reaching the proper operating temperature.

LOW VOLTAGE - If the machine is operated on low voltage, this could cause the kettle not to reach the proper operating temperature. Voltage for each leg, with kettle turned on, must be at least 110v.

INADEQUATE SUPPLY LINES - Inadequately sized electrical supply lines, in addition to being a fire hazard, would also prevent the kettle from reaching the proper operating temperature. Check with a qualified electrician.

INFERIOR CORN - Inferior quality corn would result in longer popping cycles. Use only top quality hybrid popcorn from reputable suppliers. Even then, if you let your corn pick up moisture or dry out, your popping cycles will be slow.

KETTLE DOES NOT HEAT

Before you go any further, make sure the kettle lead-in cord is plugged in and the Kettle shunt trip breaker is not tripped. The shunt trip breaker may trip during transit, if the breaker is reset then trips again; contact a service technician for inspection/repair before going any further.

KETTLE HEAT SWITCH - Check the voltage to and from the *Kettle Heat* switch, and if the switch is defective replace it.

CONTROL - A defective thermocouple lead will cause the kettle not to heat. Check for good connections from the kettle to the control.

KETTLE AGITATOR - If the kettle agitator shaft is not rotating **DO NOT** Pop corn. Adjust the clearance between the kettle bottom and the stir blade to 1/32" (use a dime). Loosen the set screw in the collars above and below the crossbar and adjust the agitator shaft as necessary. Then re-tighten the set screws in the collars.

OIL PUMP DOES NOT DELIVER OIL TO KETTLE

If the pump is operating but oil is not dispensed, the oil may be solid in the oil lines. If the pump is not operating, it may be necessary to replace it.

REPLACING BROKEN GLASS

If you accidentally break a panel of glass, it can be replaced very easily without disassembling the popper. *Gold Medal®* Products does not ship glass. Obtain from local glass shop and always purchase double strength type glass.

1. Remove all loose pieces of glass.
2. Remove all rigid glass channels from around the glass to be replaced. Set it aside as it must be reused.
3. Carefully remove the rest of broken glass.
4. Apply decals to the new glass panel.
5. Slide rigid glass channels over the exposed sides and bottom. Front and side glass slide under top and is then lowered into bottom channel.

TEMPERATURE CONTROL

The *Odyssey* has an electronic kettle control with 2 thermocouples, one for control and one for limit. There are no mechanical thermostats in this kettle.

There are (4) factory adjustments on the control:

- Control Temperature – **DO NOT** adjust this one
- Signal To Dump – If you want the signal to dump to be a little sooner or later you can adjust the potentiometer marked *Kettle Dump*. CW is sooner, CCW is later.
- The patented overshoot circuit is tuned for the kettle, **DO NOT** adjust this potentiometer.
- The audible signal to dump has three options; full volume, half volume and no sound (just the yellow light). Adjustments are by jumper positions. This is set to full volume from the factory.

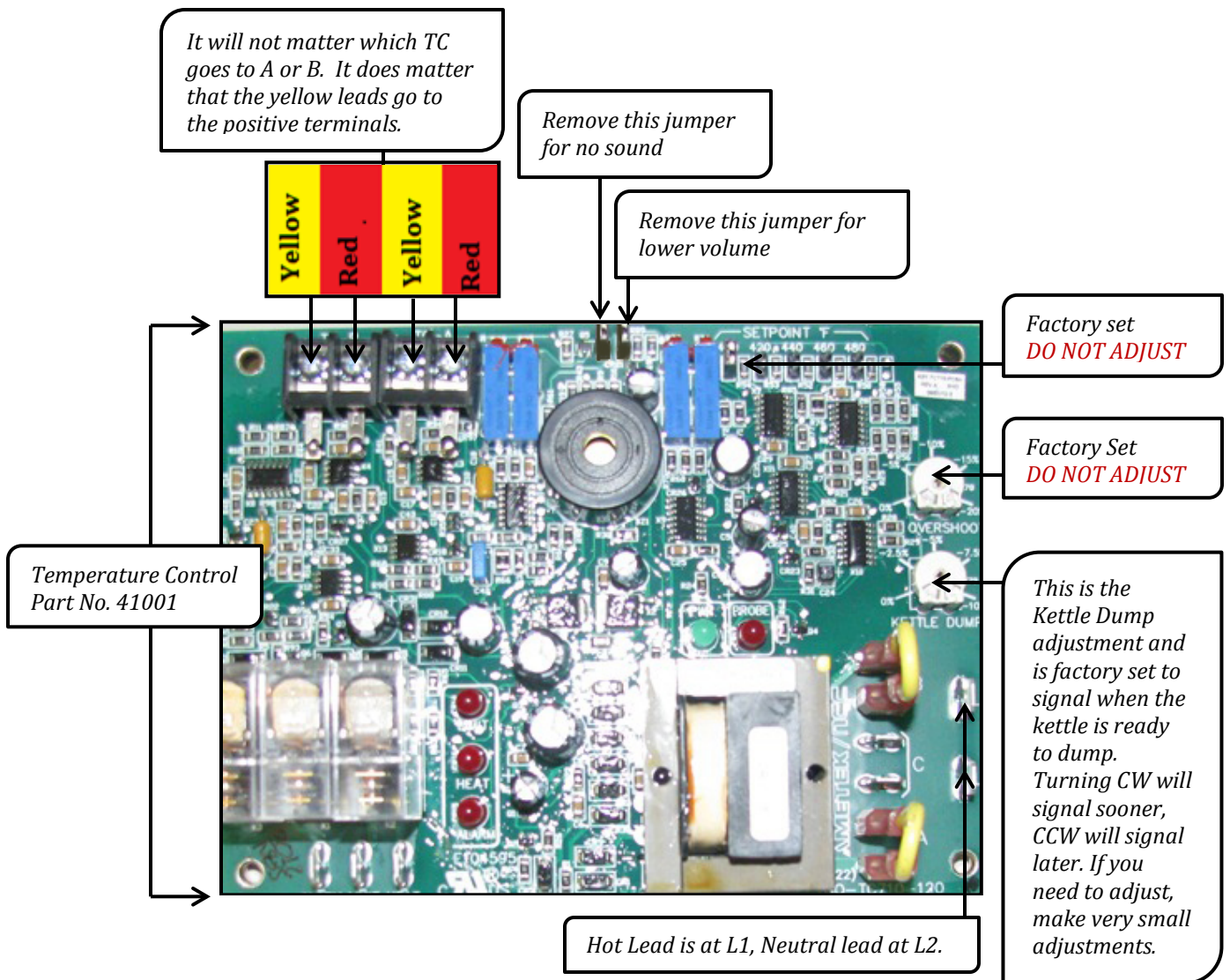



ORDERING SPARE PARTS

1. Identify the worn or broken part by checking it with the illustrations and parts list.
2. When ordering parts, include part number, part name, and quantity required.
3. Include your model name and machine serial number (found on nameplate) with your order.
4. Address orders to:

Parts Department
Gold Medal® Products Co.
10700 Medallion Drive
Cincinnati, Ohio 45241-4807

Or place orders at:

(800) 543-0862
(513) 769-7676
Fax: (513) 769-8500
E-mail: info@gmpopcorn.com
www.gmpopcorn.com



DOME BREAKDOWN

(Fluorescent Lighting)

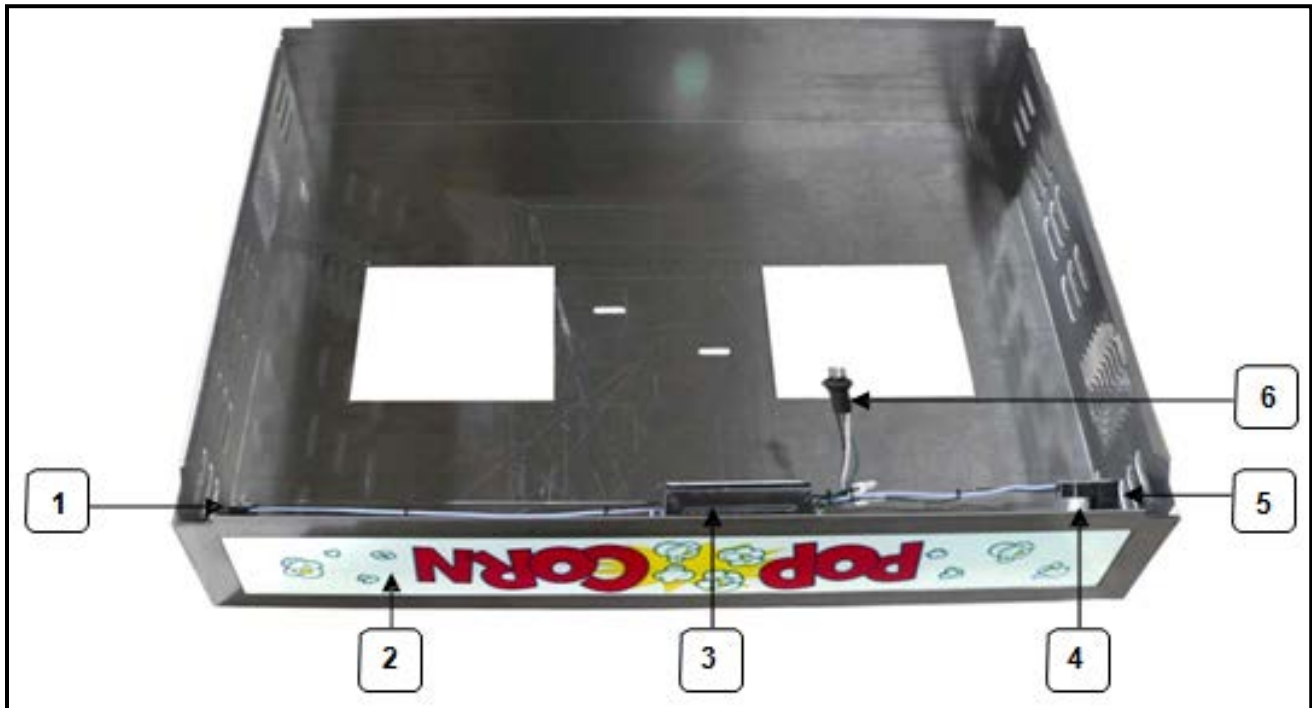

ITEM	PART NO.	PART NAME
1	41020	Light Tube Holder
2	41506	Sign Glass With Graphics
3	41509	Light Ballast
4	41508	FS-25 Starter
5	41021	Light Tube Holder For Starter
6	47726	Molded Plug

DOME BREAKDOWN

(Neon Lighting)



ITEM	PART NO.	PART NAME
1	47726	Molded Plug
2	55231	12 Volt Power Supply
3	55233	Power Supply Bracket Assy
4	67418	Clear Sign Cover (included with 67524)
5	67524	LED Sign Assembly
6	67488	Sign Brackets (x2)

DOME BREAKDOWN

(LED Lighting)



ITEM	PART NO.	PART NAME
1	82473	Popcorn Sign w/Graphics
2	55350	24V/25W Power Supply
3	47726	Molded Plug
4	55379	LED Strip (x3)

CABINET BREAKDOWN

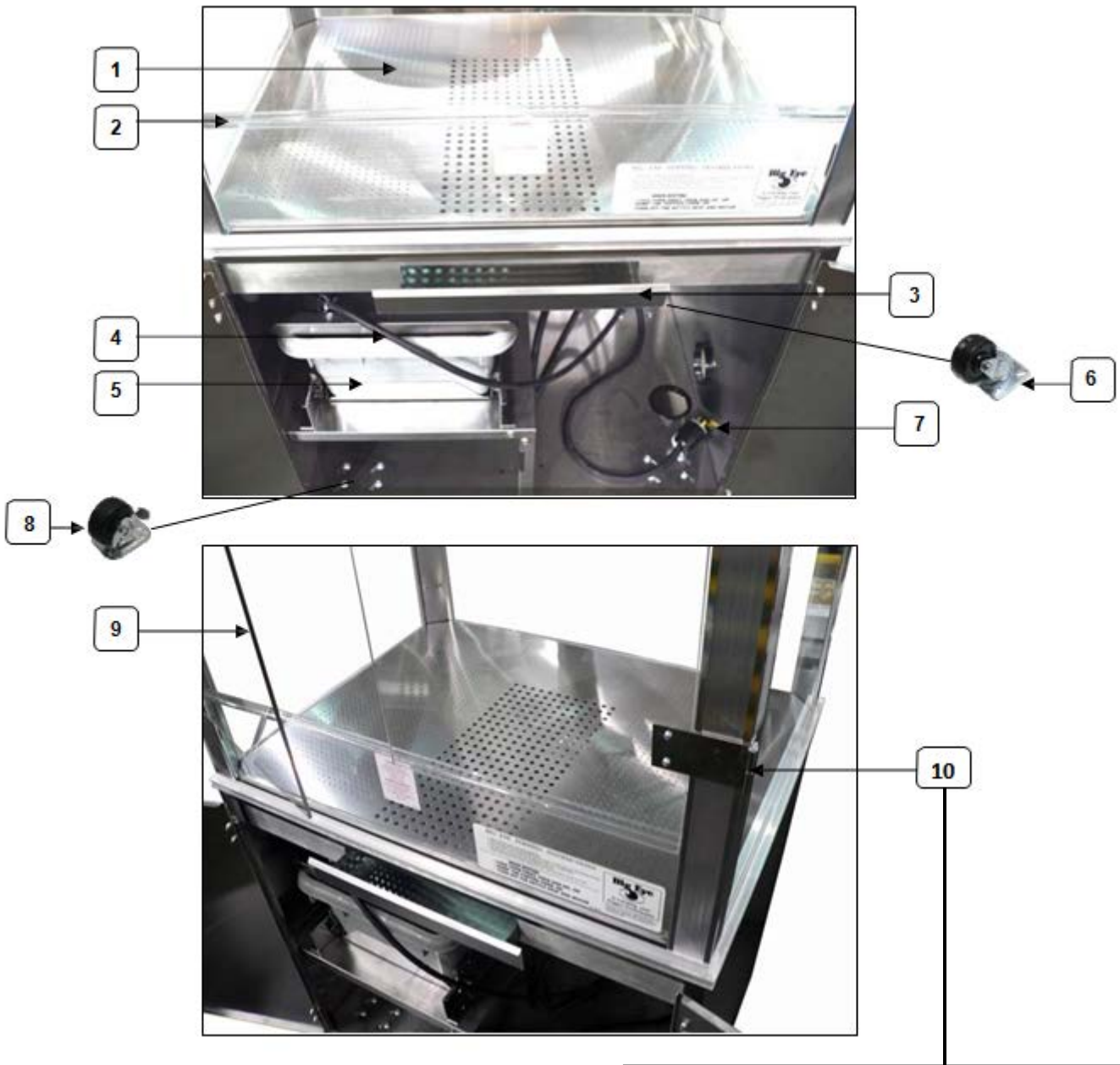

ITEM	PART NO.	PART NAME
1	41285	Corn Pan
2	61126	Plexiglas Drop Panel
3	40276	Old Maid Pan
4	41499	Wire Harness for Oil Pump
5	41689	Corn Bin
6	37513	Swivel Caster (x2)
7	16050	Power Supply Cord
8	37514	NSF Swivel Caster w/Lock (x2)
9	61129	Plexiglas Doors (x2)
10	47055	Complete Door Hardware Kit

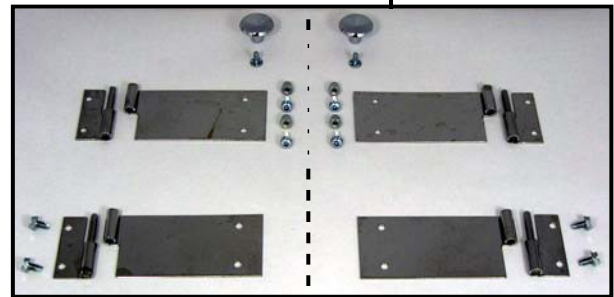

CABINET BREAKDOWN



ITEM	PART NO.	PART NAME
1	46512	LH Cabinet Drawer Slide
2	46511	RH Cabinet Drawer Slide
3	41661	Corn Bin Retainer

CABINET BREAKDOWN

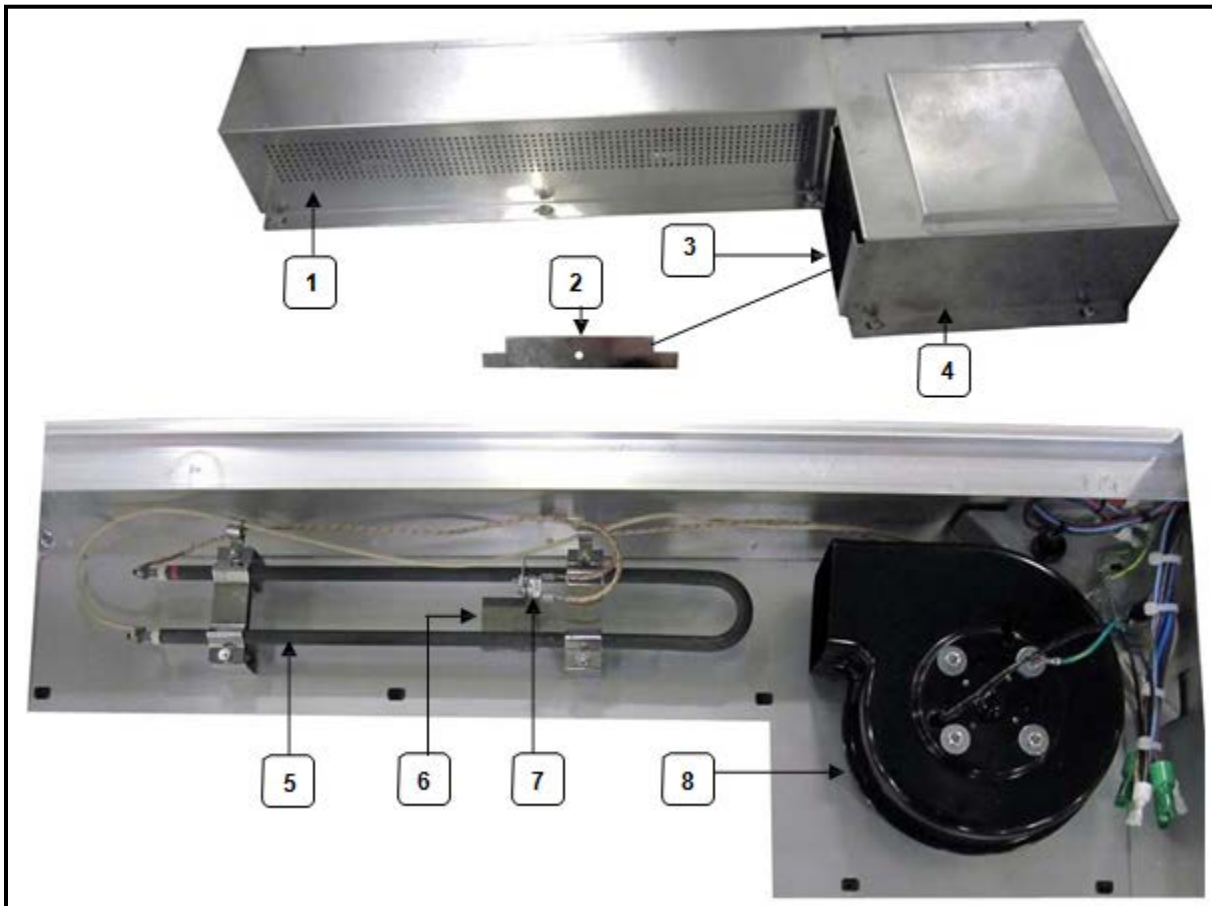

ITEM	PART NO.	PART NAME
1	61139	Diffuser Cover
2	63634	Filter Retainer
3	63633	Filter (Pack of 5 Filters)
4	62158	Blower Cover
5	61128	800 Watt Tubular Element*
6	55500	Thermostat Mounting Bracket
7	55496	Thermostat
8	61123	Blower Motor, 115V 50/60

*** NOTE:** This Element will be covered. For proper operation, you MUST remove the cover and clean underneath the element every 3 - 4 months. Be sure the machine is off and the power is disconnected before cleaning.

CABINET BREAKDOWN

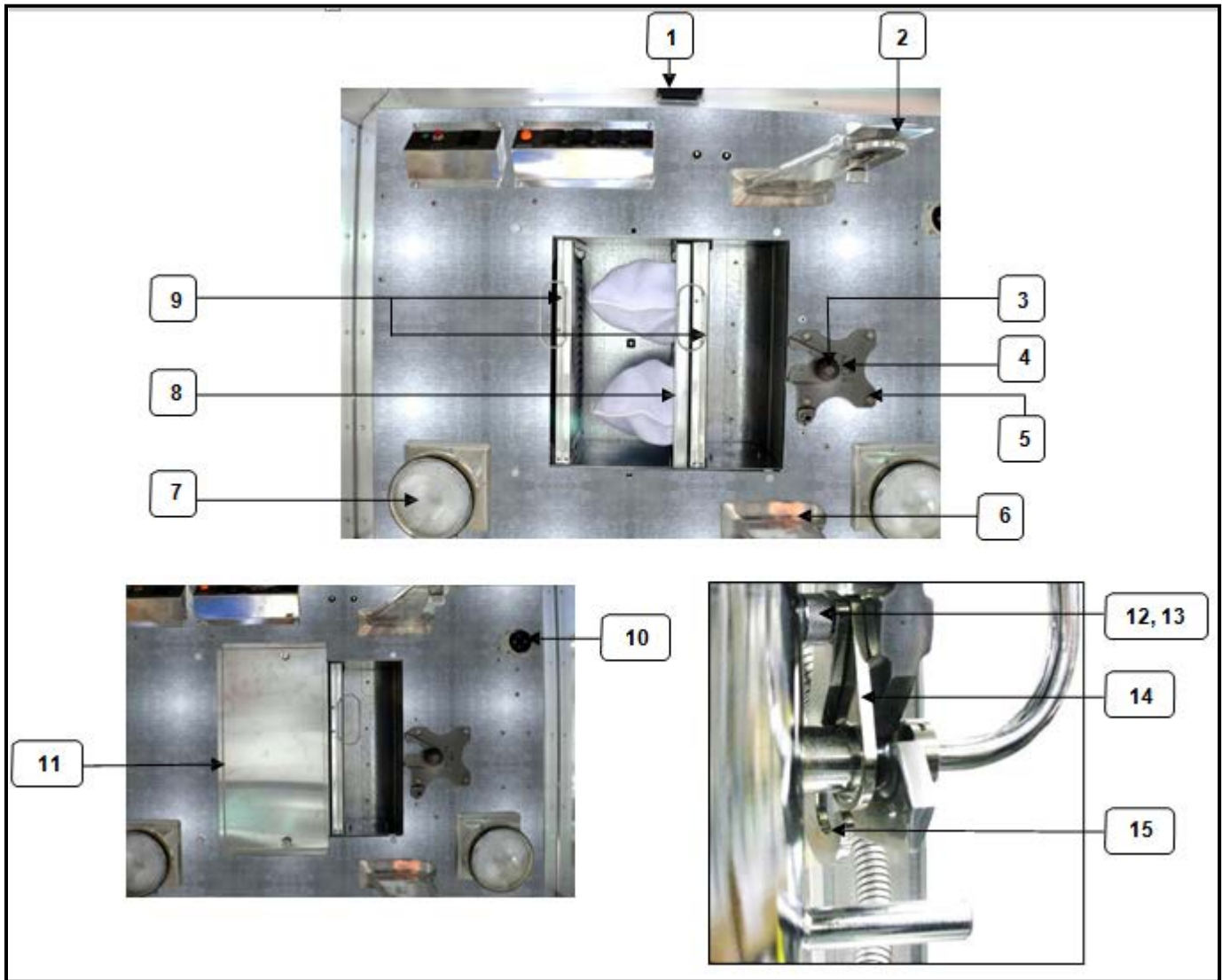

ITEM	PART NO.	PART NAME
1	47561	Magnetic Catch
2	49505	Hanger Arm Assy w/Clean-In-Place Latch
3	41742	Set Screw 10-32 x 3/16 (x2)
4	41380	Spur Gear
5	41432	Gear Block Assy
6	41941	Hanger Arm Assy
7	41979	75 Watt Halogen Lamp (x2)
8	41169	Oil Mist Filter *
9	41250	5-Layer Grease Filter (x2) *
10	55165	Kettle Receptacle Assy
11	41934	Filter Cover Assy

ITEM	PART NO.	PART NAME
12	12319	Knob
13	41448	Set Screw 10-32 x 1"
14	43426	Kettle Retainer
15	41618	Clean-In-Place Latch
16	41833	Shock Absorber Pin (Not Shown)
17	86009	Spring (Not Shown)

***All three parts are available as a Filter Pack set (Part No. 82015)**

MOTOR PLATE BREAKDOWN

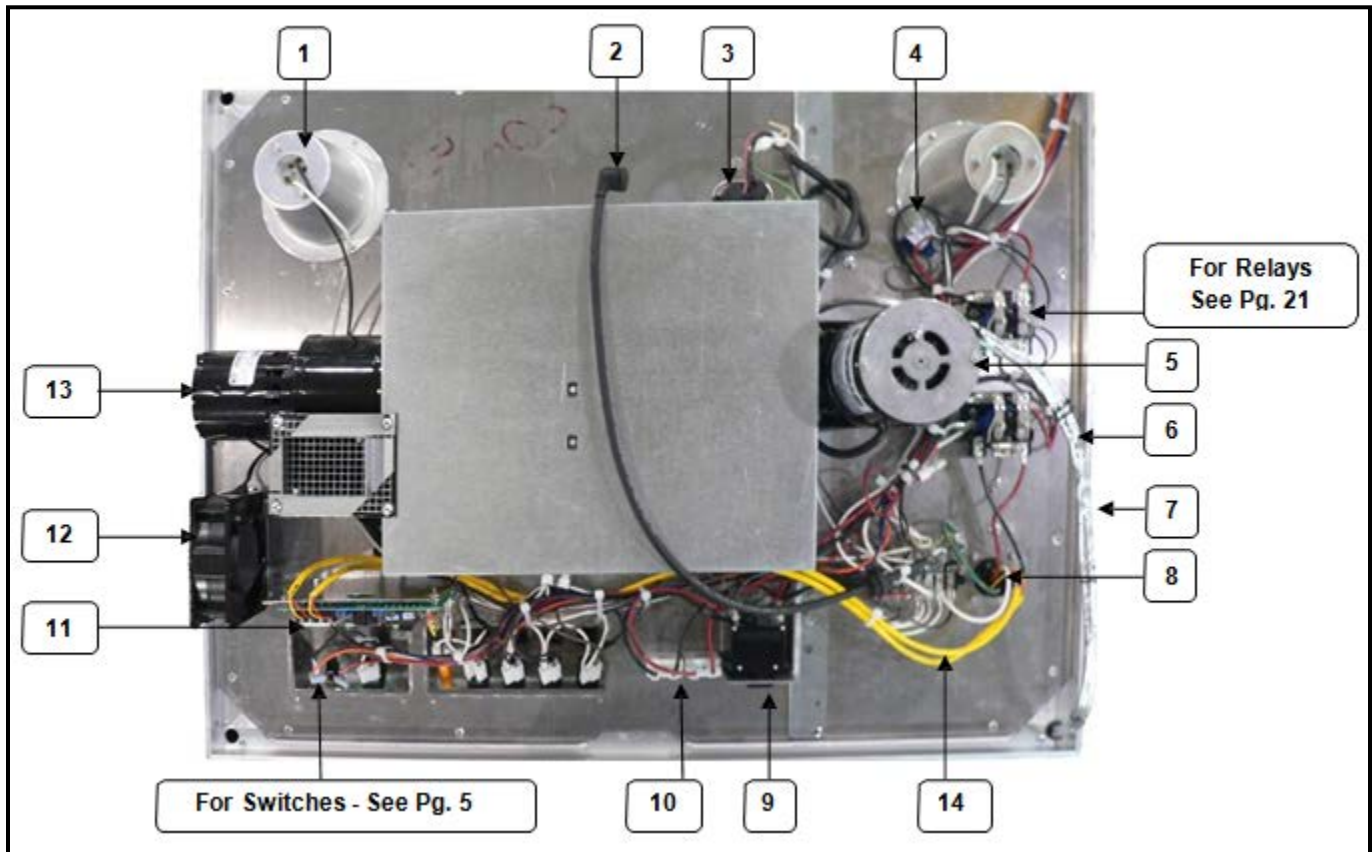

ITEM	PART NO.	PART NAME
1	47047	Lamp Holder
2	41712	Wire Harness
3	46107	Motor Capacitator 7.5 uf (Black-Bison Motor)
	46110	Motor Capacitator 10 uf (White-Franklin Motor)
4	89087	Transient Filter
5	41449R	Kettle Drive Motor
6	41640	8W Foil Element
7	41047	Aluminum Oil Tubing (sold by the ft.)
8	55165	Kettle Receptacle Assy
9	55222	Kettle Shunt Trip Breaker
	55254	Bracket
10	47364	Circuit Breaker, 15A (x2)
11	41001	Temperature Control Board
12	48018	Axial Fan
13	41015	Exhaust Blower
14	55164	Thermocouple Wire Assy (x2)*

*Included with 55165
Also sold separately

RELAY BREAKDOWN



1



2



3



4



5



6

ITEM	PART NO.	PART NAME
1	55219	Relay/30A/DPST/120V Coil/Domestic
2	46081	Relay/30A/DPDT/120V Coil/Domestic Flexi-Pop
3	48590	Relay/30A/DPST-NO/120V Coil/4 Terminals/Domestic
4	48645	Relay/30A/DPDT/120V Coil/6 Terminals/Domestic
5	89082	Contactor IEC/220V Coil/Export
6	48912	Contactor IEC/40A/120V Coil/Domestic
7	48945	Contactor IEC/32A/120V Coil/Domestic
8	89858	Relay/30A/DPDT/240V Coil/Export



7



8

Ventilation Control Components – “V” Models Only

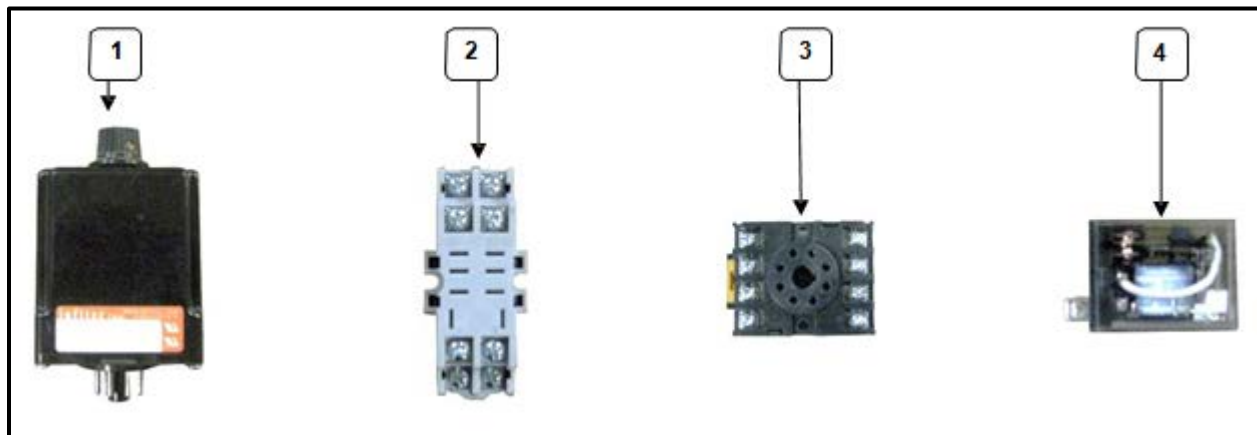

ITEM	PART NO.	PART NAME
1	55157	Timer
2	89085	Relay Socket
3	79141	8 Pin Timer Socket
4	55036	Relay

TOP HAT KETTLE BREAKDOWN

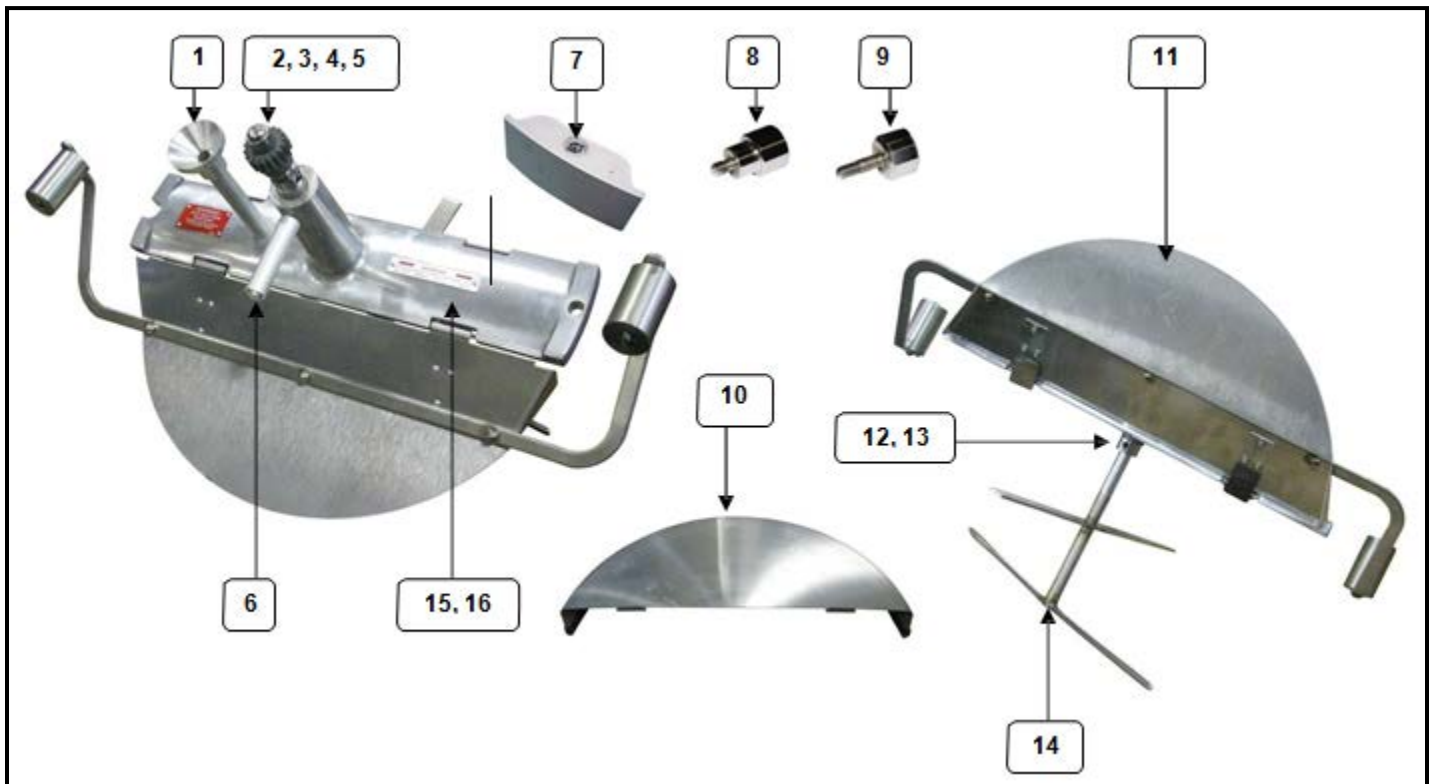

ITEM	PART NO.	PART NAME
1	41239	Oil Tube w/Funnel
2	41380	Spur Gear
3	41742	Set Screw (x2)
4	12611	Button Head Screw 5/16-18x½ LH
5	41730	Woodruff Key
6	67925	Magnet Holder Assy
7	67901	Top Hat Block (x2)
8	47976	Crossbar Fastener w/Shoulder
9	47977	Crossbar Fastener
10	67918	Fixed Rear Lid
11	68068	Front Lid Assy
12	47326	Set Collar (x2)
13	47751	Set Screw
14	41940	Agitator Assy
15	41772HT	Crossbar Assy
16	48977	Crossbar Bushings (x2)

STANDARD LID AND AGITATOR BREAKDOWN

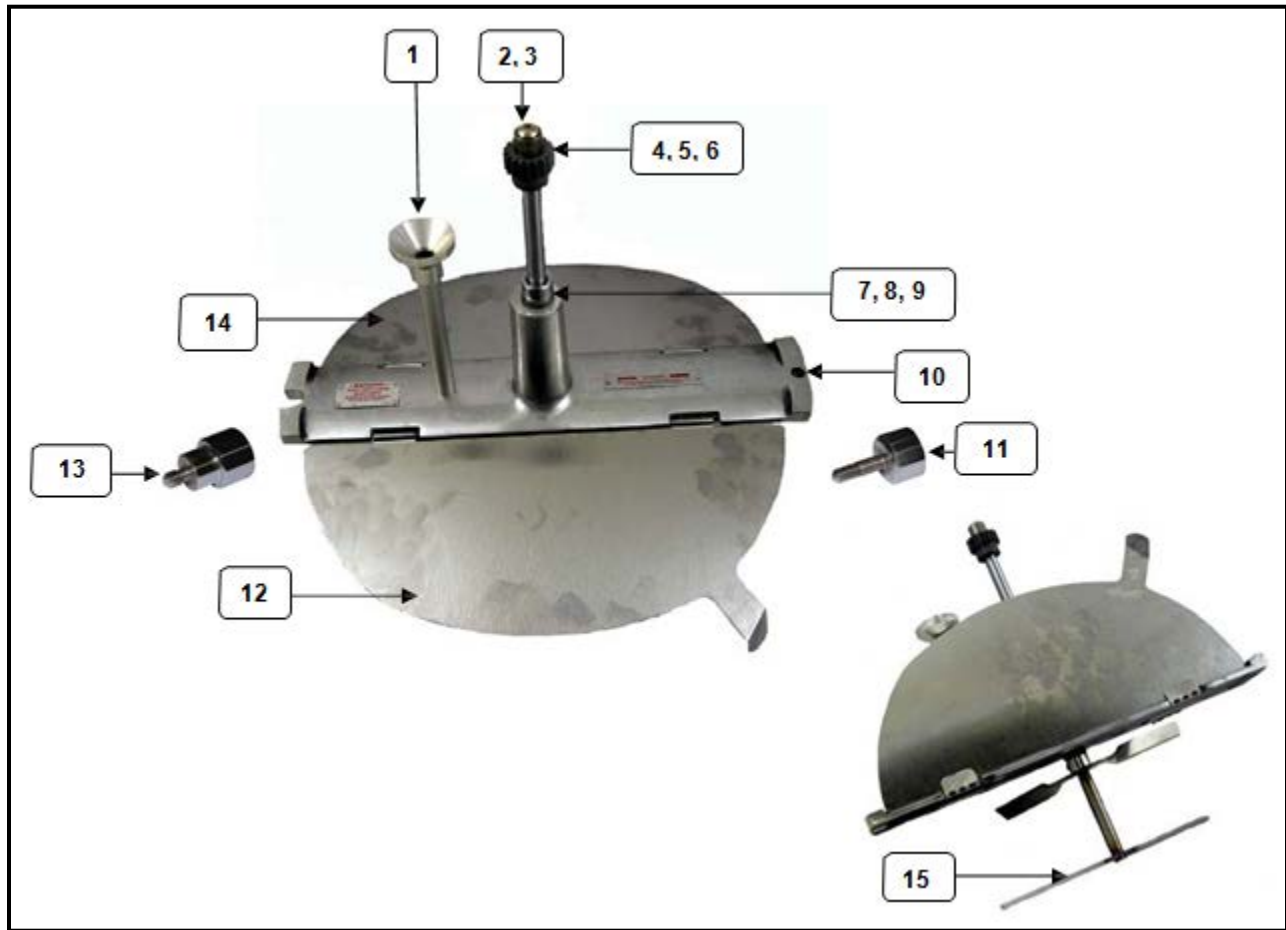

ITEM	PART NO.	PART NAME
1	47689	Oil Funnel
2	12611	Button Head Screw
3	41400	Needle Bearing
4	41380	Spur Gear
5	41730	Woodruff Key
6	41742	Set Screw 10-32 x 3/16 (x2)
7	47326	Set Collar (x2)
8	47751	Set Screw 1/4-20 x 3/16
9	48977	Cross Bar Bushing (x2)*
10	41772	Cross Bar Assy.
11	47977	Cross Bar Fastener
12	41935	Front Lid
13	47976	Cross Bar Fastener w/Shoulder
14	41936	Rear Lid
15	41940	Agitator Weld Assy

*Included with Part No. 41772

KETTLE BREAKDOWN

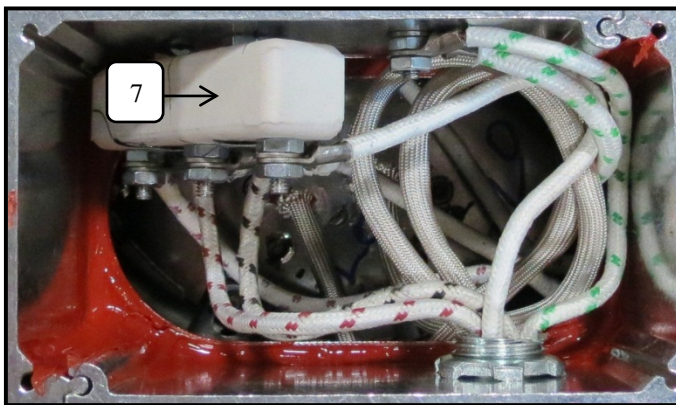
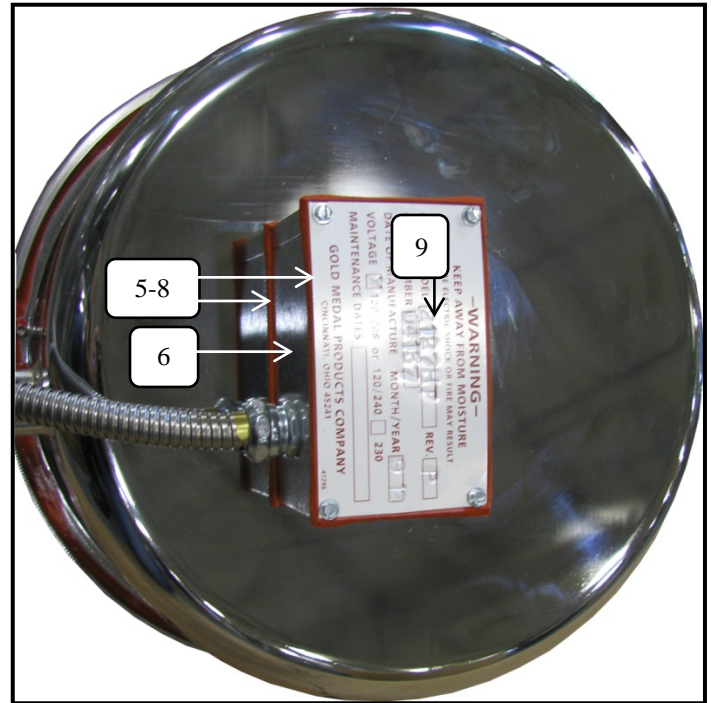
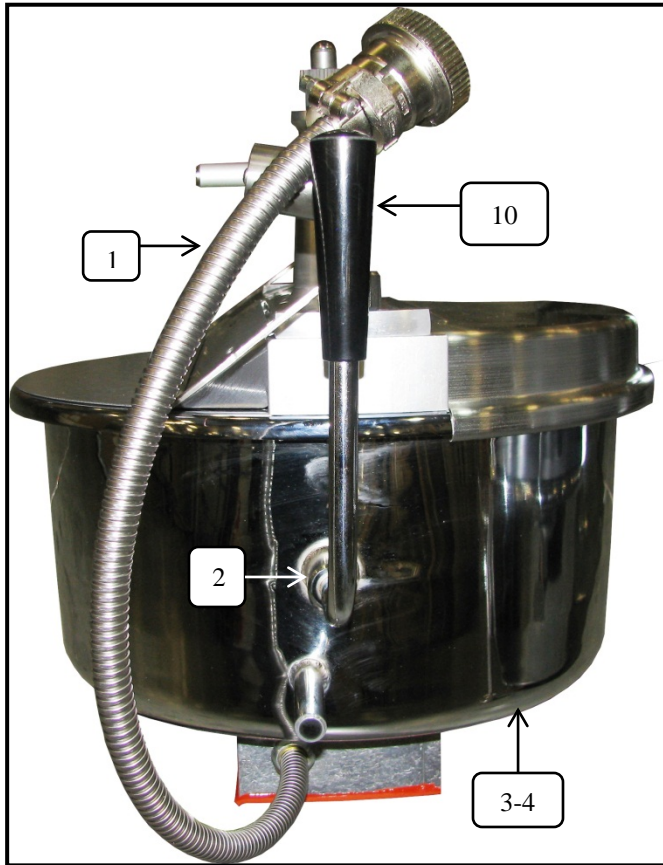

ITEM	PART NO.	PART NAME
1	55140	Kettle Lead In Assembly
2	69815	½" Split Collar (x2)
3	41528	Kettle Shell - RH Dump - Single Kettle
4	41528L	Kettle Shell - LH Dump - LH on Dual
5	40963	Junction Box Gasket w/Cutout
6	61084	Junction Box Assy
7	41129	Ceramic Terminal Block
8	40965	Junction Box Gasket w/o Cutout
9	41296	Junction Box Cover
10	41139	Plastic Dump Handle

KETTLE BOTTOM BREAKDOWN

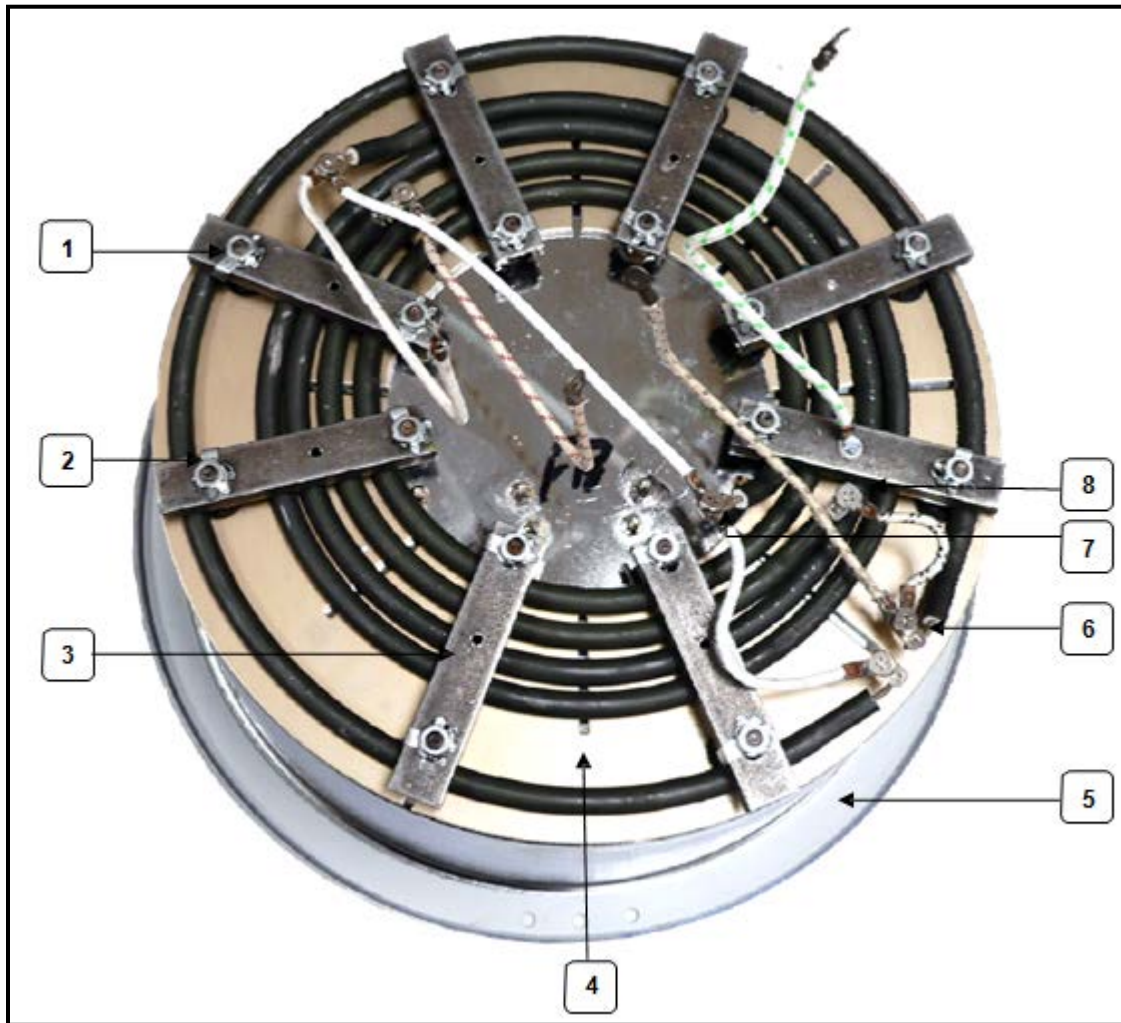

ITEM	PART NO.	PART NAME
1	50190	Nut Retainer
2	41451	1/4 - 20 Hex Jam Nut
3	41491	Element Clamp
4	41534	Heat Transfer Plate
5	41597	Kettle Gasket
6	41536	120V - 1000W Heat Element
7	48651	120V - 1050W Heat Element
8	48650	120V - 1800W Heat Element

WIRING DIAGRAM

NOTE: A Wiring Diagram is supplied with each popper. Please reference the wiring diagram enclosed with the popper.

WARRANTY

WE WARRANT to the original purchaser the Gold Medal equipment sold by us to be free from defects in material or workmanship under normal use and service. Our obligation under this warranty shall be limited to the repair or replacement of any defective part for a period of six (6) months from the date of sale to the Original Purchaser with regard to labor and two (2) years with regard to parts and does not cover damage to the equipment caused by accident, alteration, improper use, voltage, abuse, or failure to follow instructions.

THIS WARRANTY IS IN LIEU OF ALL OTHER WARRANTIES EXPRESSED OR IMPLIED, AND OF ALL OTHER OBLIGATIONS OR LIABILITIES ON OUR PART, INCLUDING THE IMPLIED WARRANTY OF MERCHANTABILITY. THERE ARE NO WARRANTIES WHICH EXTEND BEYOND THE DESCRIPTION ON THE FACE HEREOF. We neither assume, nor authorize any other person to assume for us, any other obligation or liability in connection with the sale of said GOLD MEDAL equipment or any part thereof.

The term "Original Purchaser" as used in this warranty shall be deemed to mean that person, firm, association, or corporation who was billed by the GOLD MEDAL PRODUCTS COMPANY, or their authorized distributor for the equipment.

THIS WARRANTY HAS NO EFFECT AND IS VOID UNLESS THE ORIGINAL PURCHASER FIRST CALLS GOLD MEDAL PRODUCTS COMPANY AT 1-800-543-0862 TO DISCUSS WITH OUR SERVICE REPRESENTATIVE THE EQUIPMENT PROBLEM, AND, IF NECESSARY, FOR INSTRUCTIONS CONCERNING THE REPAIR OR REPLACEMENT OF PARTS.

NOTE: This equipment is manufactured and sold for commercial use only.



GOLD MEDAL PRODUCTS COMPANY
10700 Medallion Drive
Cincinnati, Ohio 45241-4807 USA